

# M series

Variable cable carrier  
with extensive accessories  
and stay variants



Trademarks are legally protected for the TSUBAKI KABELSCHLEPP GmbH as a national or international registration in the following countries: [tsubaki-kabelschlepp.com/trademarks](http://tsubaki-kabelschlepp.com/trademarks)

Subject to change without notice

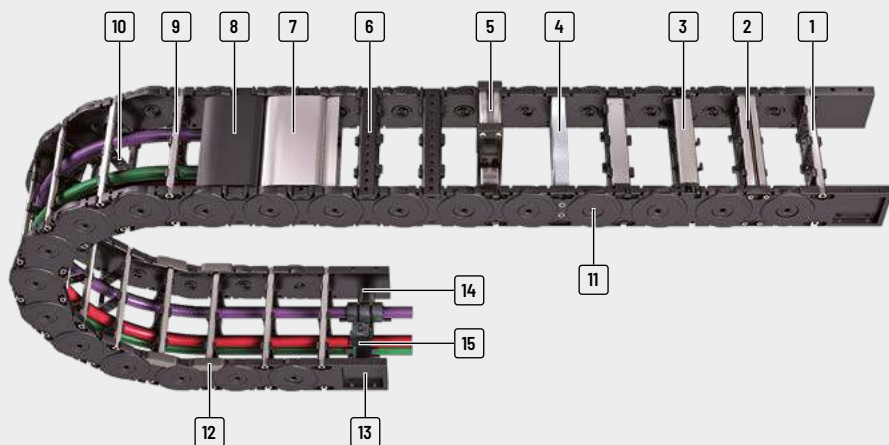

- |  |  |   |  |
|--|--|---|--|
| <p><b>1</b> Aluminum stays available in <b>1 mm width sections</b></p> <p><b>2</b> 4-fold bolted aluminum stays for extreme loads</p> <p><b>3</b> Aluminum stays with ball joint</p> <p><b>4</b> Aluminum hole stays</p> | <p><b>5</b> Mounting frame stays</p> <p><b>6</b> Plastic stays available in <b>4, 8 or 16 mm width sections</b></p> <p><b>7</b> Aluminum cover available in <b>1 mm width sections</b></p> | <p><b>8</b> Plastic cover available in <b>8 or 16 mm width sections</b></p> <p><b>9</b> Can be opened quickly on the inside and the outside for cable laying</p> <p><b>10</b> Fixable dividers</p> <p><b>11</b> Locking bolts</p> | <p><b>12</b> Replaceable glide shoes</p> <p><b>13</b> Universal end connectors (UMB)</p> <p><b>14</b> C-rail for strain relief elements</p> <p><b>15</b> Strain relief combs</p> |
|--|--|---|--|

## Features

- » Encapsulated, dirt-resistant stroke system
- » Durable sidebands through robust link plate design
- » Easy assembly of side bands through bars with easy-to-assemble locking bolts
- » Long service life due to minimized hinge wear owing to the "life extending 2 disc principle"
- » Large selection of vertical and horizontal stay systems and dividing options for your cables
- » Versions with aluminum stays in 1 mm width sections up to 800 mm inner width
- » Versions with plastic stays available in 4, 8 or 16 mm width sections



Minimized hinge wear owing to the "life extending 2 disc principle"



Sturdy link plate design, encapsulated stroke system



Easy to assemble through locking bolts



Replaceable glide shoes for long service life for gliding applications

Type	Opening variant	Stay variant	$h_i$ [mm]	$h_G$ [mm]	$B_i$ [mm]	$B_k$ [mm]	$B_i$ - grid [mm]	t [mm]	KR [mm]	Additional load ≤ [kg/m]	Cable- $d_{max}$ [mm]	
PROTUN® series	<b>M0320</b>											
K series			RS 01	19	27.5	25 - 280	36 - 291	1	32	37 - 200	2.5	15
			RS 02	19	27.5	25 - 280	36 - 291	1	32	37 - 200	2.5	15
			RE	19	27.5	25 - 189	36 - 200	4	32	37 - 200	2.5	15
UNIFLEX Advanced series	<b>M0475</b>											
M series			RD 01	28	39	24 - 280	41 - 297	8	47.5	55 - 300	3.0	22
			RD 02	28	39	24 - 280	41 - 297	8	47.5	55 - 300	3.0	22
TKHD series	<b>M0650</b>											
XL series			RS	38	57	75 - 400	109 - 434	1	65	75 - 350	25	30
			LG	36	57	75 - 600	109 - 634	1	65	75 - 350	25	29
			RMA	38 (200)	57 (224)	200 - 400	234 - 434	1	65	75 - 350	25	-
			RE	42	57	50 - 266	84 - 300	8	65	75 - 350	25	33
			RD	42	57	50 - 266	84 - 300	8	65	75 - 350	25	33
QUANTUM® series	<b>M0950</b>											
TKR series			RS	58	80	75 - 400	114 - 439	1	95	140 - 380	35	46
			RV	58	80	75 - 500	114 - 539	1	95	140 - 380	35	46
			RM	54	80	75 - 600	114 - 639	1	95	140 - 380	35	43
			LG	50	80	75 - 600	114 - 639	1	95	140 - 380	35	38
			RMA	58 (200)	80 (224)	200 - 500	239 - 539	1	95	140 - 380	35	-
			RMR	51	80	75 - 600	114 - 639	1	95	140 - 380	35	46
			RE	58	80	45 - 557	84 - 596	16	95	140 - 380	35	46
			RD	58	80	45 - 557	84 - 596	16	95	140 - 380	35	46
TKA series												
UAT series												

Unsupported arrangement			Gliding arrangement			Inner Distribution				Movement			Page
Travel length ≤ [m]	$v_{max} \leq [m/s]$	$a_{max} \leq [m/s^2]$	Travel length ≤ [m]	$v_{max} \leq [m/s]$	$a_{max} \leq [m/s^2]$	TS0	TS1	TS2	TS3	vertical hanging or standing	lying on the side	rotating arrangement	
2.8	10	50	80	2.5	25	•	•	-	-	•	•	•	356
2.8	10	50	80	2.5	25	•	•	-	-	•	•	•	356
2.8	10	50	80	2.5	25	•	•	-	-	•	•	•	358
2.7	10	50	-	-	-	•	•	•	-	•	•	•	364
2.7	10	50	-	-	-	•	•	•	-	•	•	•	366
4.8	10	40	220	8	20	•	•	•	•	•	•	•	372
4.8	10	40	220	8	20	-	-	-	-	•	•	•	376
4.8	10	40	220	8	20	•	-	-	-	•	•	-	378
4.8	10	40	220	8	20	•	•	-	•	•	•	•	380
4.8	10	40	220	8	20	•	•	-	•	•	•	•	381
7.4	10	30	260	8	20	•	•	•	•	•	•	•	390
7.4	10	30	260	8	20	•	•	•	•	•	-	•	394
7.4	10	30	260	8	20	•	•	•	-	•	•	•	398
7.4	10	30	260	8	20	-	-	-	-	•	•	•	400
7.4	10	30	260	8	20	•	-	-	-	•	•	-	402
7.4	10	30	260	8	20	•	-	-	-	•	•	•	404
7.4	10	30	260	8	20	•	•	•	•	•	•	•	406
7.4	10	30	260	8	20	•	•	•	•	•	•	•	407

Subject to change without notice.

PROTUM® series

K series

UNIFLEX Advanced series

M series

TKHD series

XL series

QUANTUM® series

TKR series

TKA series

UAT series

Type	Opening variant	Stay variant	$h_i$ [mm]	$h_G$ [mm]	$B_i$ [mm]	$B_k$ [mm]	$B_i$ - grid [mm]	t [mm]	KR [mm]	Additional load ≤ [kg/m]	Cable- d <sub>max</sub> [mm]
<b>M1250</b>											
K series		RS	72	96	75 - 400	120 - 445	1	125	180 - 500	65	61
		RV	72	96	100 - 600	145 - 645	1	125	180 - 500	65	61
UNIFLEX Advanced series		RM	69	96	100 - 800	145 - 845	1	125	180 - 500	65	59
		LG	76	96	100 - 800	145 - 845	1	125	180 - 500	65	59
M series		RMA	72 (200)	96 (226)	200 - 800	245 - 845	1	125	180 - 500	65	-
		RMR	66	96	100 - 800	145 - 845	1	125	180 - 500	65	54
		RE	72	96	71 - 551	116 - 596	16	125	180 - 500	65	61
		RD	72	96	71 - 551	116 - 596	16	125	180 - 500	65	61
<b>M1300</b>											
TKHD series		RMF	87	120	100 - 800	150 - 850	1	130	150 - 500	70	75
		RMS	87	120	100 - 800	150 - 850	1	130	150 - 500	70	75
XL series		LG	98	120	100 - 800	150 - 850	1	130	150 - 500	70	74

\* Further information on request.

QUANTUM®  
seriesTKR  
seriesTKA  
seriesUAT  
series

Unsupported arrangement			Gliding arrangement			Inner Distribution				Movement			Page
Travel length ≤ [m]	$v_{max} \leq [m/s]$	$a_{max} \leq [m/s^2]$	Travel length ≤ [m]	$v_{max} \leq [m/s]$	$a_{max} \leq [m/s^2]$	TS0	TS1	TS2	TS3	vertical hanging or standing	lying on the side	rotating arrangement	
9.7	10	25	320	8	20	•	•	-	•	•	•	•	416
9.7	10	25	320	8	20	•	•	•	•	•	-	•	420
9.7	10	25	320	8	20	•	•	•	-	•	•	•	424
9.7	10	25	320	8	20	-	-	-	-	•	•	•	426
9.7	10	25	320	8	20	•	-	-	-	•	•	-	428
9.7	10	25	320	8	20	•	-	-	-	•	•	•	430
9.7	10	25	320	8	20	•	•	•	•	•	•	•	432
9.7	10	25	320	8	20	•	•	•	•	•	•	•	433
10.8	10	25	350	8	20	•	•	-	•	-	-	-	440
10.8	10	25	350	8	20	•	•	-	•	•	•	•	442
10.8	10	25	350	8	20	-	-	-	-	•	•	•	444

PROTUM® series

K series

UNIFLEX Advanced series

**M series**

TKHD series

XL series

QUANTUM® series

TKR series

TKA series

UAT series

# M0320

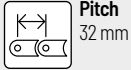

**Pitch**  
32 mm



**Inner height**  
19 mm



**Inner widths**  
25 – 280 mm



**Bending radii**  
37 – 200 mm

## Stay variants



**Aluminum stay 01**..... page 356

### Frame stay detachable inside

- » Aluminum profile bars for light to medium loads.  
Assembly without screws.
- » **Inside:** release by turning by 90°.



**Aluminum stay 02**..... page 356

### Frame stay detachable outside "the standard"

- » Aluminum profile bars for light to medium loads.  
Assembly without screws.
- » **Outside:** release by turning by 90°.



**Plastic stay RE**..... page 358

### Frame screw-in stay

- » Plastic profile bars for light to medium loads.  
Assembly without screws.
- » **Inside/outside:** release by turning by 90°.

## More product information online



Assembly instructions etc.:  
Additional info via your  
smartphone or check online at  
[tsubaki-kabelschlepp.com/  
downloads](http://tsubaki-kabelschlepp.com/downloads)



Configure your custom  
cable carrier here:  
[online-engineer.de](http://online-engineer.de)

Unsupported arrangement

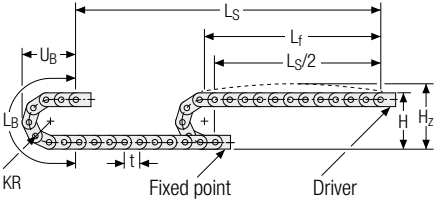

KR [mm]	H [mm]	H <sub>z</sub> [mm]	L <sub>B</sub> [mm]	U <sub>B</sub> [mm]
37	101.5	121.5	181	83
47	121.5	141.5	212	93
77	181.5	201.5	306	123
100	227.5	247.5	379	146
200	427.5	427.5	693	246

Load diagram for unsupported length depending on the additional load.

Sagging of the cable carrier is technically permitted for extended travel lengths, depending on the specific application.

Intrinsic cable carrier weight  $q_k = 0.54 \text{ kg/m}$ . For other inner widths, the maximum additional load changes.

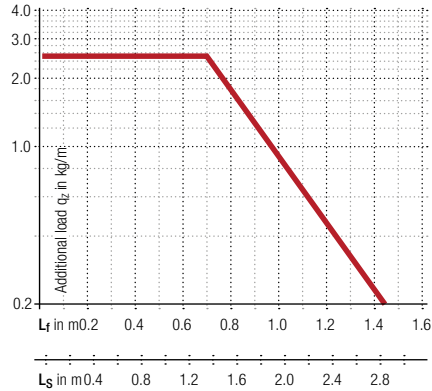

**Speed**  
up to 10 m/s

**Acceleration**  
up to 50 m/s<sup>2</sup>

**Travel length**  
up to 2.8 m

**Additional load**  
up to 2.5 kg/m

Gliding arrangement

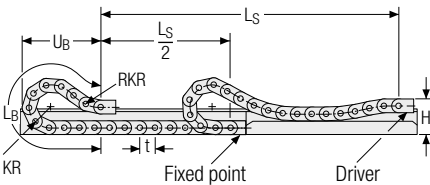

**Speed**  
up to 2.5 m/s

**Acceleration**  
up to 25 m/s<sup>2</sup>

The gliding cable carrier must be guided in a channel. See p. 842.

**Travel length**  
up to 80 m

**Additional load**  
up to 2.5 kg/m

Our technical support can provide help for gliding arrangements:  
[technik@kabelschlepp.de](mailto:technik@kabelschlepp.de)

PROTUM® series
K series
UNIFLEX Advanced series
M series
TKHD series
XL series
QUANTUM® series
TKR series
TKA series
UAT series



## Aluminum stay 01/02 – frame stay detachable outside

- Extremely quick to open and close
- Aluminum profile bars for light to medium loads.  
Assembly without screws.
- Available customized in **1 mm** grid.
- **Outside/inside:** release by turning by 90°.

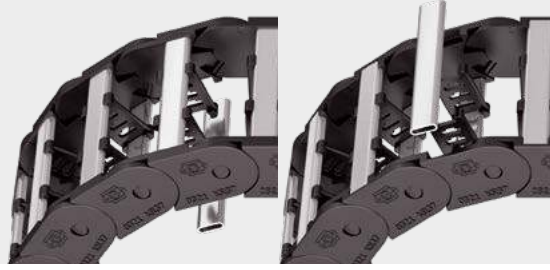

Stay arrangement on each chain link (**VS: fully-stayed**)



**1 mm** B<sub>i</sub> 25 – 280 mm  
in 1 mm width sections

### Aluminum stay 01 frame stay detachable inside

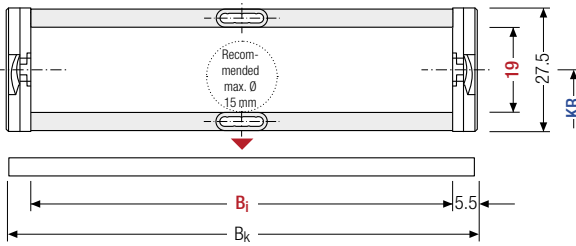

The maximum cable diameter strongly depends on the bending radius and the desired cable type. Please contact us.

#### Calculating the cable carrier length

**Cable carrier length L<sub>k</sub>**

$$L_k \approx \frac{L_s}{2} + L_B$$

Cable carrier length L<sub>k</sub>  
rounded to pitch t

### Aluminum stay 02 frame stay detachable outside

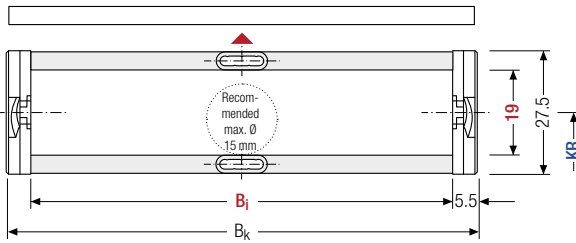

h <sub>i</sub> [mm]	h <sub>g</sub> [mm]	B <sub>i</sub> [mm]*	B <sub>k</sub> [mm]	KR [mm]			q <sub>k</sub> [kg/m]		
19	27.5	25 – 280	B <sub>i</sub> + 11	37	47	77	100	200	0.47 – 1.70

\* in 1 mm width sections

#### Order example



MC0320

Type

200

B<sub>i</sub> [mm]

01

Stay variant

100

KR [mm]

1152

L<sub>k</sub> [mm]

VS

Stay arrangement

### Divider systems

As a standard, the divider system is mounted on each crossbar – for stay mounting on every 2<sup>nd</sup> chain link (HS).

As a standard, dividers and the complete divider system (dividers with height separations) can be moved in the cross section (**version A**).

### Divider system TSO without height separation

Vers.	a <sub>T</sub> min [mm]	a <sub>x</sub> min [mm]	a <sub>c</sub> min [mm]	n <sub>T</sub> min
A	3	6	4	2

The dividers can be moved in the cross section.

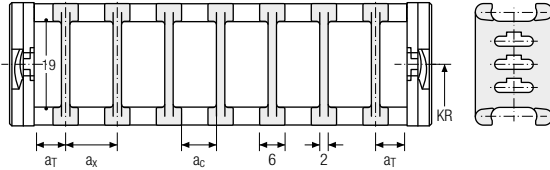

### Divider system TS1 with continuous height separation

Vers.	a <sub>T</sub> min [mm]	a <sub>T</sub> max [mm]	a <sub>x</sub> min [mm]	a <sub>c</sub> min [mm]	n <sub>T</sub> min
A	3	20	6	4	2

The dividers can be moved in the cross section.

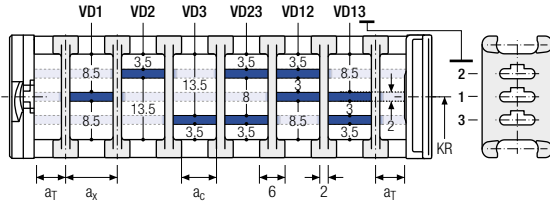

### Order example

TS1

A

3

VD1

⋮

VD3

Divider system

Version

n<sub>T</sub>

Height separation

Please state the designation of the divider system (**TS0, TS1 ...**), version and number of dividers per cross section [n<sub>T</sub>].

If using divider systems with height separation (**TS1**) please also state the positions [e.g. VD1] viewed from the left driver belt. You are welcome to add a sketch to your order.

PROTUM® series
K series
UNIFLEX Advanced series
M series
TKHD series
XL series
QUANTUM® series
TKR series
TKA series
UAT series

## Plastic stay RE – screw-in frame stay

- Plastic profile bars for light to medium loads.  
Assembly without screws.
- Available customized in **4 mm grid**.
- **Outside/inside:** release by turning by 90°.



Stay arrangement on each chain link (**VS: fully-stayed**)



**4 mm** B<sub>i</sub> 25 – 189 mm  
in 4 mm width sections

**M**  
series

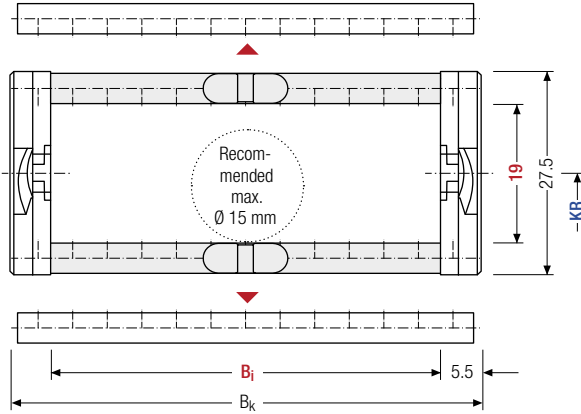

The maximum cable diameter strongly depends on the bending radius and the desired cable type. Please contact us.

### Calculating the cable carrier length

**Cable carrier length L<sub>k</sub>**

$$L_k \approx \frac{L_S}{2} + L_B$$

Cable carrier length L<sub>k</sub>  
rounded to pitch t

**XL**  
series

**QUANTUM**<sup>®</sup>  
series

**TKR**  
series

h <sub>i</sub> [mm]	h <sub>G</sub> [mm]	B <sub>i</sub> [mm]											B <sub>k</sub> [mm]	KR [mm]	q <sub>k</sub> [kg/m]		
19	27.5	25	29	33	37	41	45	49	53	57	61	65	B <sub>i</sub> + 11	37	47	0.46	
		69	73	77	81	85	89	93	97	101	105	109		77	100		–
		113	117	121	125	129	133	137	141	145	149	200		1.00			



For B<sub>i</sub> > 149 mm we recommend a multi-band chain.

### Order example



**ME0320**

Type

**105**

B<sub>i</sub> [mm]

**RE**

Stay variant

**100**

KR [mm]

**1152**

L<sub>k</sub> [mm]

**VS**

Stay arrangement

**UAT**  
series

Divider systems

As a standard, the divider system is mounted on each crossbar – for stay mounting on every 2<sup>nd</sup> chain link (HS).

As a standard, dividers and the complete divider system (dividers with height separations) can be moved in the cross section (**version A**).

The dividers are easily attached to the stay for applications with lateral acceleration and for applications laying on their side by simply turning the frame stay by 180°. The arresting cams click into place in the locking grids in the crossbars (**version B**). The groove in the frame stay faces outwards.

Divider system TSO without height separation

Vers.	a <sub>T</sub> min [mm]	a <sub>x</sub> min [mm]	a <sub>c</sub> min [mm]	a <sub>x</sub> grid [mm]	n <sub>T</sub> min
A	3	6	4	–	–
B	4.5	8	6	4	–

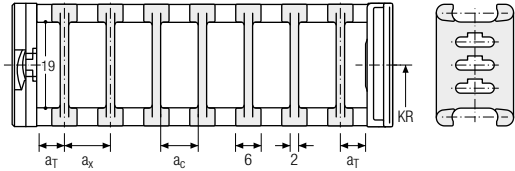

The dividers can be moved in the cross section.

Divider system TS1 with continuous height separation

Vers.	a <sub>T</sub> min [mm]	a <sub>T</sub> max [mm]	a <sub>x</sub> min [mm]	a <sub>c</sub> min [mm]	a <sub>x</sub> grid [mm]	n <sub>T</sub> min
A	3	20	6	4	–	2
B	4.5	20.5	8	6	4	2

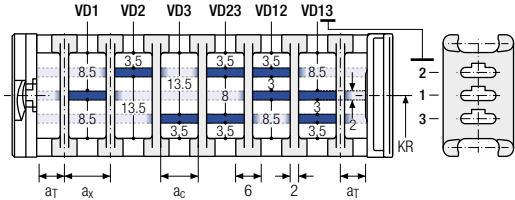

The dividers can be moved in the cross section.

Order example

TS1

A

3

VD1

⋮

VD3

Divider system

Version

n<sub>T</sub>

Height separation

Please state the designation of the divider system (**TS0, TS1 ...**), version and number of dividers per cross section [n<sub>T</sub>].

If using divider systems with height separation (**TS1**), please also state the positions [e.g. VD1] viewed from the left driver belt. You are welcome to add a sketch to your order.

PROTUM® series
K series
UNIFLEX Advanced series
M series
TKHD series
XL series
QUANTUM® series
TKR series
TKA series
UAT series

## One part end connectors – plastic/aluminum (with integrated strain relief)

The plastic/aluminum end connectors can be **connected from above or below**. The connection variants on the fixed point and on the driver can be combined and, if required, changed afterwards.

## One-part end connectors – plastic/aluminum

The plastic/aluminum end connectors can be **connected from above or below**. The connection variants on the fixed point and on the driver can be combined and, if required, changed afterwards.

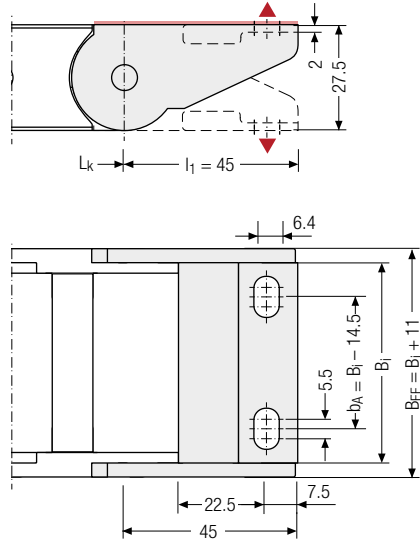
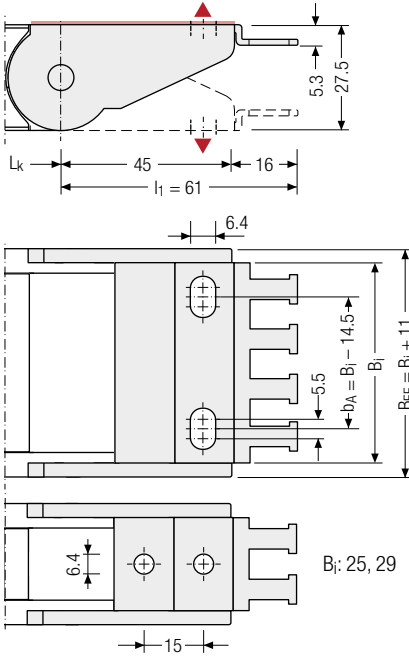

▲ Assembly options

$B_i$ [mm]	$n_z$	$B_i$ [mm]	$n_z$	$B_i$ [mm]	$n_z$	$B_i$ [mm]	$n_z$
25	2	39	4	89	7	149	11
29	2	49	4	109	8		
37	3	69	5	124	10		

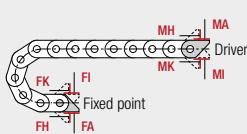

### Connection point

- F – fixed point
- M – driver

### Connection type

- A – threaded joint outside (standard)
- I – threaded joint inside
- H – threaded joint, rotated 90° to the outside
- K – threaded joint, rotated 90° to the inside

## Order example

Plastic/aluminum	F	A
Plastic/aluminum	M	A
End connector	Connection point	Connection type



We recommend the use of strain reliefs at the driver and fixed point. See from p. 902.



Subject to change without notice.

PROTUM®  
series

K  
series

UNIFLEX  
Advanced  
series

**M**  
series

TKHD  
series

XL  
series

QUANTUM®  
series

TKR  
series

TKA  
series

UAT  
series

# M0475

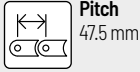

**Pitch**  
47.5 mm



**Inner height**  
28 mm



**Inner widths**  
24 - 280 mm



**Bending radii**  
55 - 300 mm

## Stay variants



**Plastic stay RD 01** ..... page **364**

### Frame stay with hinge in the inner radius

- » Plastic profile bars with hinge for light to medium loads.  
Assembly without screws.
- » **Outside:** release by turning by 90°.
- » **Inside:** swivable to both sides.



**Plastic stay RD 02** ..... page **366**

### Frame stay with hinge in the outer radius

- » Plastic profile bars with hinge for light to medium loads.  
Assembly without screws.
- » **Outside:** swivable to both sides.
- » **Inside:** release by turning by 90°.



### MT series

Also available as covered variants with cover system.  
More information can be found  
in chapter "MT series" from p. 610.

## More product information online



Assembly instructions etc.:  
Additional info via your smartphone  
or check online at  
[tsubaki-kabelschlepp.com/  
downloads](http://tsubaki-kabelschlepp.com/downloads)



Configure your custom  
cable carrier here:  
**online-engineer.de**

Unsupported arrangement

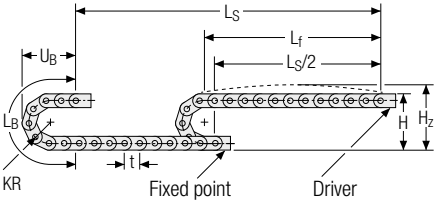

KR [mm]	H [mm]	H <sub>z</sub> [mm]	L <sub>B</sub> [mm]	U <sub>B</sub> [mm]
55	149	174	268	122
75	189	214	331	142
100	239	264	410	167
130	299	324	504	197
160	359	384	598	227
200	439	464	724	267
250	539	564	881	317
300	639	664	1038	367

Load diagram for unsupported length depending on the additional load.

Sagging of the cable carrier is technically permitted for extended travel lengths, depending on the specific application.

Intrinsic cable carrier weight  $q_k = 1.7 \text{ kg/m}$ . For other inner widths, the maximum additional load changes.

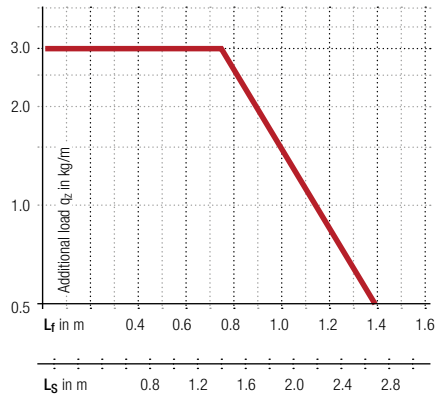

**Speed**  
up to 10 m/s

**Acceleration**  
up to 50 m/s<sup>2</sup>

**Travel length**  
up to 2.7 m

**Additional load**  
up to 3.0 kg/m

PROTUM® series
K series
UNIFLEX Advanced series
<b>M series</b>
TKHD series
XL series
QUANTUM® series
TKR series
TKA series
UAT series



## Plastic stay RD 01 – frame stay with hinge in the inner radius

- Plastic profile bars with hinge for light to medium loads. Assembly without screws.
- Available customized in **8 mm grid**.
- **Outside:** release by turning by 90°.  
**Inside:** swivable to both sides.



Stay arrangement on every chain link (**VS: fully-stayed**)



**8 mm** B<sub>i</sub> 24 – 280 mm  
in 8 mm width sections

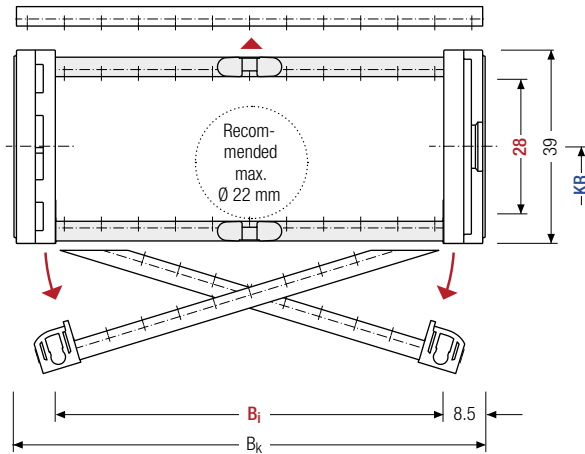

The maximum cable diameter strongly depends on the bending radius and the desired cable type. Please contact us.

### Calculating the cable carrier length

#### Cable carrier length $L_k$

$$L_k \approx \frac{L_s}{2} + L_B$$

Cable carrier length  $L_k$   
rounded to pitch  $t$

$h_i$ [mm]	$h_G$ [mm]	$B_i$ [mm]										$B_k$ [mm]	$KR$ [mm]	$q_k$ [kg/m]		
28	39	24	32	40	48	56	64	72	80	88	96	$B_i + 17$	55	75	0.79	
		104	112	120	128	136	144	152	160	168	176		100	130		–
		184	192	200	208	216	224	232	240	248	256		160	200		3.03
		264	272	280	250	300										

### Order example



**MK0475**

Type

**128**

$B_i$  [mm]

**RD 01**

Stay variant

**100**

$KR$  [mm]

**1425**

$L_k$  [mm]

**VS**

Stay arrangement

### Divider systems

As a standard, the divider system is mounted on each crossbar – for stay mounting on every 2<sup>nd</sup> chain link (HS).

As a standard, dividers and the complete divider system (dividers with height separations) can be moved in the cross section (**version A**).

The dividers are easily attached to the stay for applications with lateral acceleration and for applications laying on their side by simply turning the frame stay by 180°. The arresting cams click into place in the locking grids in the crossbars (**version B**). The groove in the frame stay faces outwards.

### Divider system TSO without height separation

Vers.	a <sub>T</sub> min [mm]	a <sub>x</sub> min [mm]	a <sub>c</sub> min [mm]	a <sub>x</sub> grid [mm]	n <sub>T</sub> min
A	6	7.8	5	–	–
B	12	8	5.2	8	–

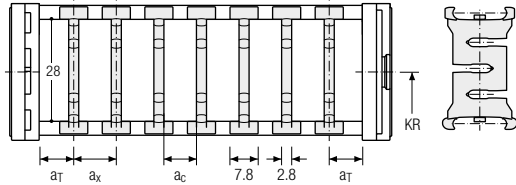

The dividers can be moved within the cross section (version A) or fixed (version B).

### Divider system TS1 with continuous height separation

Vers.	a <sub>T</sub> min [mm]	a <sub>T</sub> max [mm]	a <sub>x</sub> min [mm]	a <sub>c</sub> min [mm]	a <sub>x</sub> grid [mm]	n <sub>T</sub> min
A	6	20	7.8	5	–	2
B	12	20	8	5.2	8	2

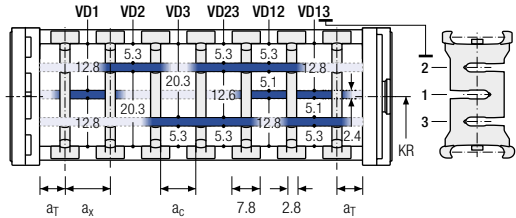

The dividers can be moved within the cross section (version A) or fixed (version B).

### Divider system TS2 with partial height separation

Vers.	a <sub>T</sub> min [mm]	a <sub>x</sub> min [mm]	a <sub>c</sub> min [mm]	a <sub>x</sub> grid [mm]	n <sub>T</sub> min
B	12	8*/24	5.2*/21.2	8	2

\* for VR0

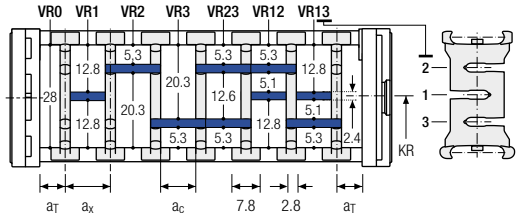

With grid distribution (8 mm grid). The dividers are fixed by the height separation, the complete divider system is movable in the cross section (version A) or fixed (version B).

### Order example

TS2 · 
 A · 
 3 · 
 K1 · 
 34 - 
 VR1  
 ⋮  
 ⋮  
K4 · 
 38 - 
 VR3

Divider system
Version
n<sub>T</sub>
Chamber
a<sub>x</sub>
Height separation

PROTUM® series
K series
UNIFLEX Advanced series
M series
TKHD series
XL series
QUANTUM® series
TKR series
TKA series
UAT series

## Plastic stay RD 02 – frame stay with hinge in the outer radius

- Plastic profile bars with hinge for light to medium loads. Assembly without screws.
- Available customized in **8 mm grid**.
- **Outside:** swivable to both sides.  
**Inside:** release by turning by 90°.



Stay arrangement on every chain link (VS: fully-stayed)



8 mm B<sub>i</sub> 24 – 280 mm in 8 mm width sections

PROTUM® series

K series

UNIFLEX Advanced series

M series

TKHD series

XL series

QUANTUM® series

TKR series

TKA series

UAT series

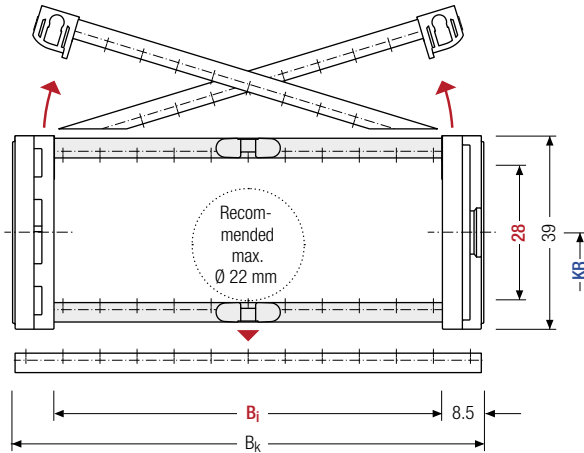

The maximum cable diameter strongly depends on the bending radius and the desired cable type. Please contact us.

### Calculating the cable carrier length

#### Cable carrier length L<sub>k</sub>

$$L_k \approx \frac{L_S}{2} + L_B$$

Cable carrier length L<sub>k</sub> rounded to pitch t

h <sub>i</sub> [mm]	h <sub>g</sub> [mm]	B <sub>i</sub> [mm]										B <sub>k</sub> [mm]	KR [mm]	q <sub>k</sub> [kg/m]	
28	39	24	32	40	48	56	64	72	80	88	96	B <sub>i</sub> + 17	55	75	0.79 – 3.03
		104	112	120	128	136	144	152	160	168	176		100	130	
		184	192	200	208	216	224	232	240	248	256		160	200	
		264	272	280	250	300									

### Order example



MK0475

Type

128

B<sub>i</sub> [mm]

RD 02

Stay variant

100

KR [mm]

1425

L<sub>k</sub> [mm]

VS

Stay arrangement



## End connectors – plastic/steel (with strain relief)

Link end connector made of plastic, end connector made of sheet steel with screw-fixed aluminum strain relief. The connection variants on the fixed point and on the driver can be combined and, if required, changed afterwards.

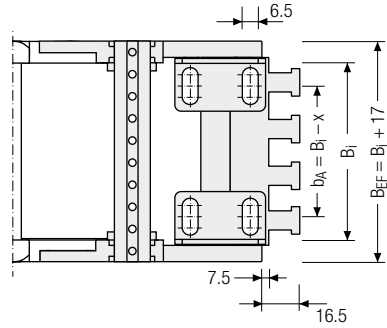
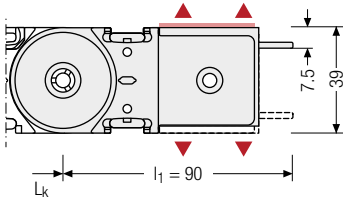

▲ Assembly options

$B_i$ [mm]	$x$ [mm]	$n_z$
40	17.5	3
56	21.5	4
80	17.5	6
104	19.0	8
128	19.5	9
152	17.5	11
192	18.5	14

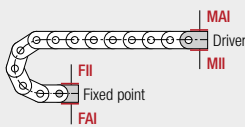

**Connection point**  
**F** – fixed point  
**M** – driver

**Connection surface**  
**I** – connection surface inside

**Connection type**  
**A** – threaded joint outside (standard)  
**I** – threaded joint inside

## Order example

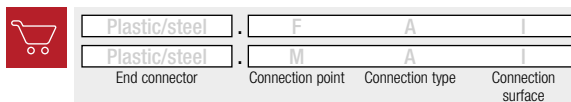

End connectors – plastic/steel

Plastic link end connector, steel end connector. The connection variants on the fixed point and on the driver can be combined and, if required, changed afterwards.

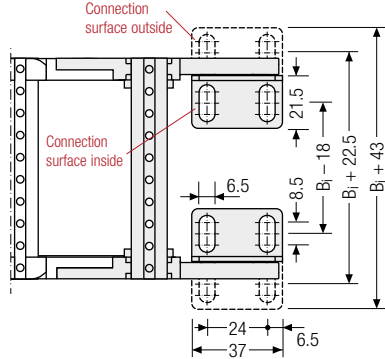
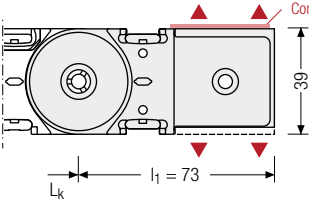

▲ Assembly options

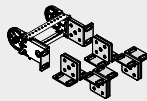
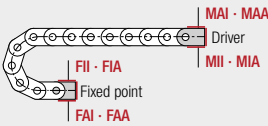

Connection point

- F – fixed point
- M – driver

Connection surface

- I – connection surface inside
- A – connection surface outside

Connection type

- A – threaded joint outside (standard)
- I – threaded joint inside
- F – flange connection

Order example

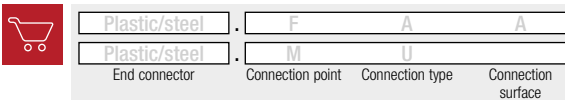

We recommend the use of strain reliefs at the driver and fixed point. See from p. 902.

PROTUM® series
K series
UNIFLEX Advanced series
<b>M series</b>
TKHD series
XL series
QUANTUM® series
TKR series
TKA series
UAT series

# M0650

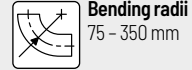
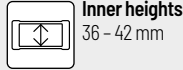
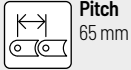

## Stay variants



**Aluminum stay RS** ..... page 372

### Frame stay, narrow "The standard"

- » Aluminum profile bars for light to medium loads.  
Assembly without screws.
- » **Outside/inside:** release by turning by 90°.

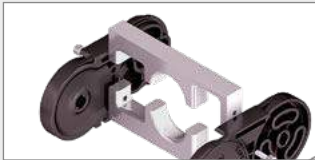

**Aluminum stay LG** ..... page 376

### Hole stay, split version

- » Optimum cable routing in the neutral bending line.  
Split version for easy cable routing. Stays also available unsplit.
- » **Outside/inside:** Screw-fixing easy to release.



**Aluminum stay RMA** ..... page 378

### Mounting frame stay

- » Aluminum profile bars with plastic mounting frame stays for guiding very large cable diameters.
- » **Outside/inside:** Screw-fixing easy to release.



**Plastic stay RE** ..... page 380

### Frame screw-in stay

- » Plastic profile bars for light to medium loads. Assembly without screws.
- » **Outside/inside:** release by turning by 90°.



**Plastic stay RD** ..... page 381

### Frame stay with hinge

- » Plastic profile bars with hinge for light to medium loads.  
Assembly without screws.
- » **Outside:** swivable to both sides.
- » **Inside:** release by turning by 90°.



Also available as covered variants with cover system.  
More information can be found in chapter "MT series" from p. 610.

Unsupported arrangement

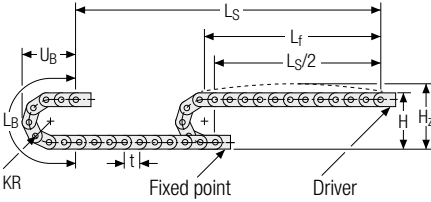

KR [mm]	H [mm]	H <sub>z</sub> [mm]	L <sub>B</sub> [mm]	U <sub>B</sub> [mm]
75	207	242	366	169
95	247	282	429	189
115	287	322	492	209
145	347	382	586	239
175	407	442	680	269
220	497	532	822	314
260	577	612	948	354
275	607	642	994	369
300	657	692	1073	394
350	757	792	1230	444

Load diagram for unsupported length depending on the additional load.

Sagging of the cable carrier is technically permitted for extended travel lengths, depending on the specific application.

Intrinsic cable carrier weight  $q_k = 2.4 \text{ kg/m}$ . For other inner widths, the maximum additional load changes.

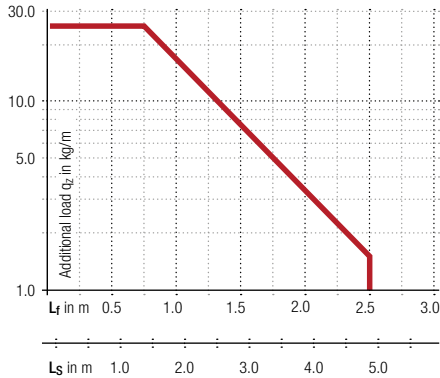

- Speed**  
up to 10 m/s
- Acceleration**  
up to 40 m/s<sup>2</sup>
- Travel length**  
up to 4.8 m
- Additional load**  
up to 25 kg/m

Gliding arrangement | GO module with chain links optimized for gliding

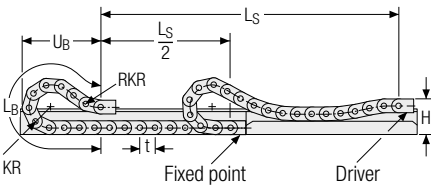

KR [mm]	H [mm]	GO module RKR [mm]	L <sub>B</sub> [mm]	U <sub>B</sub> [mm]
95	171	300	1180	560
115	171	300	1310	605
145	171	300	1440	640
175	171	300	1635	705
220	171	300	1950	810
260	171	300	2275	926
275	171	300	2405	973
300	171	300	2535	1014
350	171	300	2925	1152

- Speed**  
up to 8 m/s
- Acceleration**  
up to 20 m/s<sup>2</sup>
- Travel length**  
up to 220 m
- Additional load**  
up to 25 kg/m

The gliding cable carrier must be guided in a channel. See p. 842.

The GO module mounted on the driver is a defined sequence of 5 adapted KR/RKR link plates.

Glide shoes have to be used for gliding applications.

PROTUM® series
K series
UNIFLEX Advanced series
M series
TKHD series
XL series
QUANTUM® series
TKR series
TKA series
UAT series



## Aluminum stay RS – frame stay narrow

- Extremely quick to open and close
- Aluminum profile bars for light to medium loads.  
Assembly without screws.
- Available customized in **1 mm grid**.
- **Outside/inside:** release by turning by 90°.

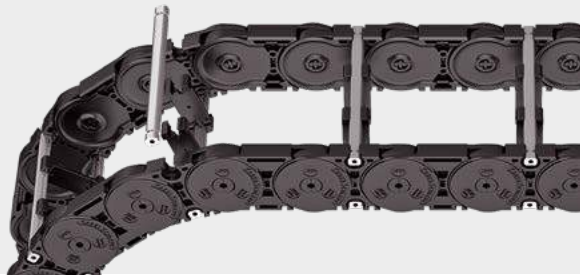

Stay arrangement on every  
2<sup>nd</sup> chain link, **standard**  
(HS: half-stayed)



Stay arrangement on each  
chain link (**VS: fully-stayed**)



**1 mm** B<sub>i</sub> 75 – 400 mm  
in **1 mm width sections**

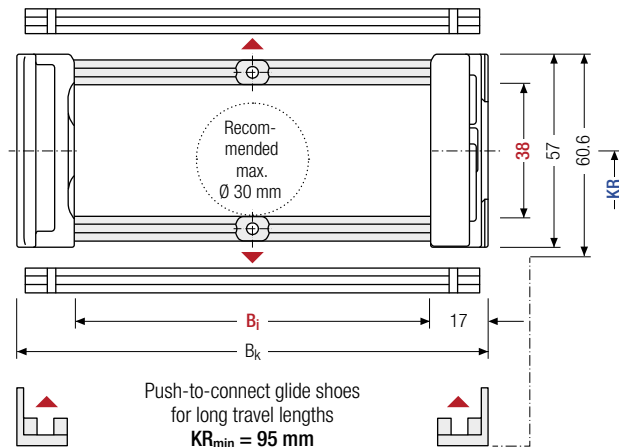

The maximum cable diameter strongly depends on the bending radius and the desired cable type. Please contact us.

For rough environmental conditions, we recommend the use of OFFROAD glide shoes with 80 % higher wear volume.

### Calculating the cable carrier length

**Cable carrier length L<sub>k</sub>**

$$L_k \approx \frac{L_s}{2} + L_B$$

Cable carrier length L<sub>k</sub>  
rounded to pitch t

h <sub>i</sub> [mm]	h <sub>G</sub> [mm]	h <sub>G'</sub> [mm]	h <sub>G'</sub> Offroad [mm]	B <sub>i</sub> [mm]*	B <sub>k</sub> [mm]	KR [mm]					q <sub>k</sub> [kg/m]
38	57	60.6	62.2	75 – 400	B <sub>i</sub> + 34	75	95	115	145	175	1.98 – 3.85
						220	260	275	300	350	

\* in 1 mm width sections

### Order example



**MC0650**

Type

**300**

B<sub>i</sub> [mm]

**RS**

Stay variant

**175**

KR [mm]

**1430**

L<sub>k</sub> [mm]

**HS**

Stay arrangement

Divider systems

As a standard, the divider system is mounted on each crossbar – for stay mounting on every 2<sup>nd</sup> chain link (HS).  
As a standard, dividers and the complete divider system (dividers with height separations) can be moved in the cross section (**version A**).

For applications with lateral acceleration and rotated by 90°, the dividers can be attached by simply clipping on to a socket (available as an accessory).  
The bushing additionally serves as a spacer between the dividers and is available in 1 mm sections between 3 – 50 mm. The inner height is reduced to 32 mm (**version B**).

Divider system TSO without height separation

Vers.	a <sub>T</sub> min [mm]	a <sub>x</sub> min [mm]	a <sub>c</sub> min [mm]	n <sub>T</sub> min
A	6.5	13	10	2

The dividers can be moved in the cross section.

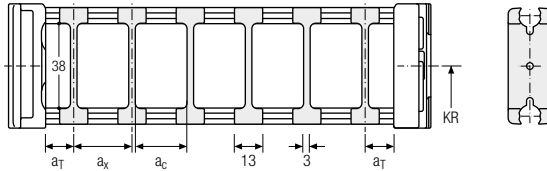

Divider system TS1 with continuous height separation

Vers.	a <sub>T</sub> min [mm]	a <sub>T</sub> max [mm]	a <sub>x</sub> min [mm]	a <sub>c</sub> min [mm]	n <sub>T</sub> min
A	6.5	25	13	10	2

The dividers can be moved in the cross section.

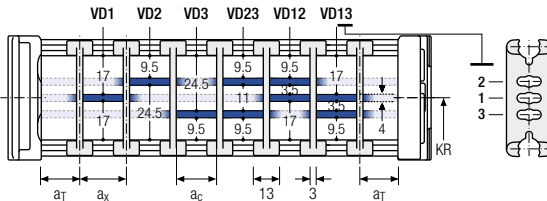

Divider system TS2 with partial height separation

Vers.	a <sub>T</sub> min [mm]	a <sub>x</sub> min [mm]	a <sub>c</sub> min [mm]	n <sub>T</sub> min
A	1.5	21	15	2

With grid distribution (1 mm grid).  
The dividers are attached by the height separation, the grid can be moved in the cross section.

Sliding dividers are optionally available (thickness of divider = 3 mm).

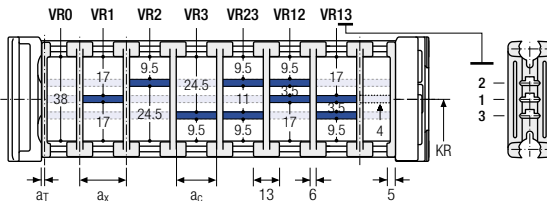

PROTUM® series
K series
UNIFLEX Advanced series
<b>M series</b>
TKHD series
XL series
QUANTUM® series
TKR series
TKA series
UAT series



**TRAXLINE® cables for cable carriers**  
Hi-flex electric cables which were especially developed, optimized and tested for use in cable carriers can be found at [tsubaki-kabelschlepp.com/traxline](http://tsubaki-kabelschlepp.com/traxline)

## Divider system TS3 with height separation made of plastic partitions

Vers.	$a_T$ min [mm]	$a_x$ min [mm]	$a_c$ min [mm]	$n_T$ min
A	4	16 / 42*	8	2

\* For aluminum partitions

The dividers are fixed by the partitions, the complete divider system is movable in the cross section.

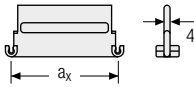
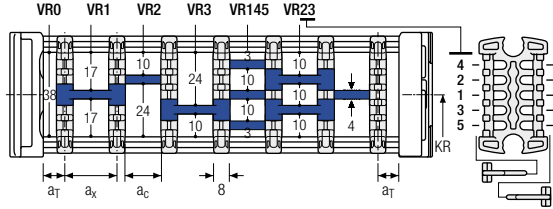

Aluminum partitions in 1 mm increments with  $a_x > 42$  mm are also available.

$a_x$ (center distance of dividers) [mm]											
$a_c$ (nominal width of inner chamber) [mm]											
16	18	23	28	32	33	38	43	48	58	64	68
8	10	15	20	24	25	30	35	40	50	56	60
78	80	88	96	112	128	144	160	176	192	208	
70	72	80	88	104	120	136	152	168	184	200	

When using **plastic partitions with  $a_x > 112$  mm**, we recommend an additional center support with a **twin divider** ( $S_T = 3$  mm). Twin dividers are also suitable for retrofitting in the partition system.

### Order example

	TS3	.	A	.	3	.	K1	.	34	-	VR1
							⋮		⋮		⋮
							K4	.	38	-	VR3
	Divider system		Version		$n_T$		Chamber		$a_x$		Height separation

Please state the designation of the divider system (**TS0, TS1 ...**), version and number of dividers per cross section [ $n_T$ ]. In addition, please also enter the chambers [K] from left to right, as well as the assembly distances [ $a_T/a_x$ ] (as seen from the driver).

If using divider systems with height separation (**TS1, TS3**) please also state the positions [e.g. VD23] viewed from the left driver belt. You are welcome to add a sketch to your order.

### More product information online



Assembly instructions etc.:  
Additional info via your  
smartphone or check online at  
[tsubaki-kabelschlepp.com/  
support](http://tsubaki-kabelschlepp.com/support)



Configure your custom  
cable carrier here:  
**online-engineer.de**

PROTUM®  
seriesK  
seriesUNIFLEX  
Advanced  
series**M**  
seriesTKHD  
seriesXL  
seriesQUANTUM®  
seriesTKR  
seriesTKA  
seriesUAT  
series

## Aluminum stay LG – Hole stay, split version

- Optimum cable routing in the neutral bending line.  
Split version for easy cable routing. Stays also available unsplit.
- Available customized in **1 mm width sections**.
- **Outside/inside:** Screw-fixing easy to release.



Stay arrangement on every 2<sup>nd</sup> chain link, **standard** (HS: half-stayed)



Stay arrangement on each chain link (**VS: fully-stayed**)



**1 mm** B<sub>i</sub> 75 – 600 mm in **1 mm width sections**

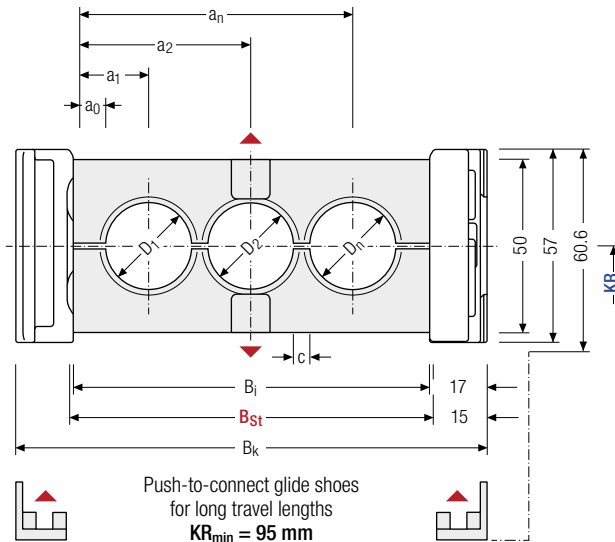

The maximum cable diameter strongly depends on the bending radius and the desired cable type. Please contact us.

### Calculating the cable carrier length

#### Cable carrier length $L_k$

$$L_k \approx \frac{L_s}{2} + L_B$$

Cable carrier length  $L_k$  rounded to pitch  $t$

### Calculating the stay width

#### Stay width $B_{St}$

$$B_{St} = \sum D + \sum c + 2 a_0$$

D <sub>max</sub> [mm]	D <sub>min</sub> [mm]	h <sub>G</sub> [mm]	B <sub>i</sub> [mm]	B <sub>St</sub> [mm]*	B <sub>k</sub> [mm]	c <sub>min</sub> [mm]	a <sub>0</sub> min [mm]	KR [mm]					q <sub>k</sub> 50%** [kg/m]
36	9	57	75 – 600	79 – 604	B <sub>St</sub> + 30	4	10	75	95	115	145	175	2.39 – 4.66
								220	260	275	300	350	

\* in 1 mm width sections

\*\* Hole ratio of the hole stay approx. 50 %

### Order example



MC0650

Type

300

B<sub>i</sub> [mm]

LG

Stay variant

175

KR [mm]

1430

L<sub>k</sub> [mm]

HS

Stay arrangement

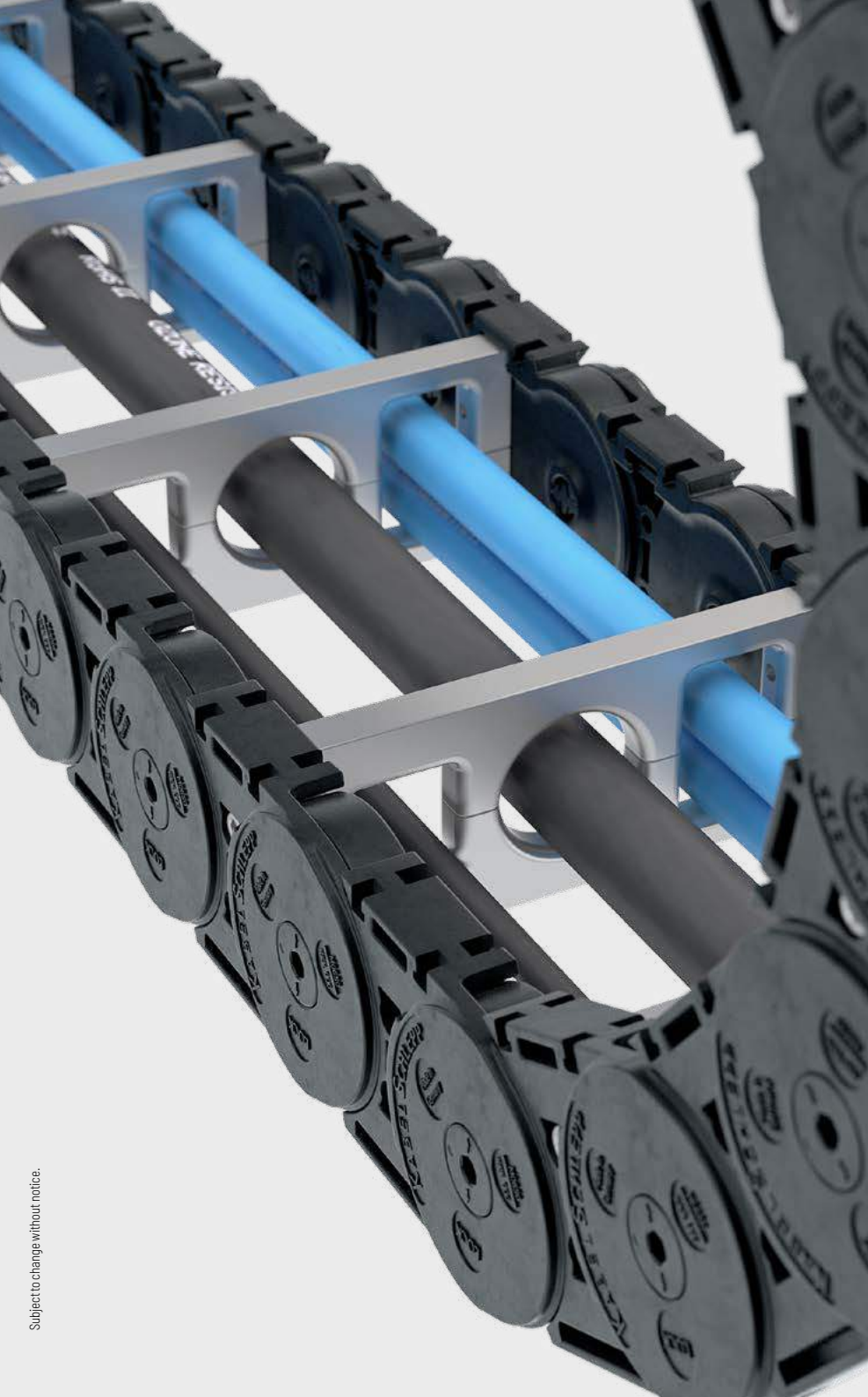

PROTUM®  
series

K  
series

UNIFLEX  
Advanced  
series

**M**  
series

TKHD  
series

XL  
series

QUANTUM®  
series

TKR  
series

TKA  
series

UAT  
series

## Aluminum stay RMA – mounting frame stay

- Aluminum profile bars with plastic mounting frame stays for guiding very large cable diameters.
- The mounting frame stay can be mounted either inside or outside in the bending radius. Available customized in **1 mm width sections**.
- **Outside/inside:** Screw-fixing easy to release.



Stay arrangement on every 2<sup>nd</sup> chain link, **standard** (HS: half-stayed)



Stay arrangement on each chain link (**VS: fully-stayed**)



$B_i$  200 – 400 mm in **1 mm width sections**

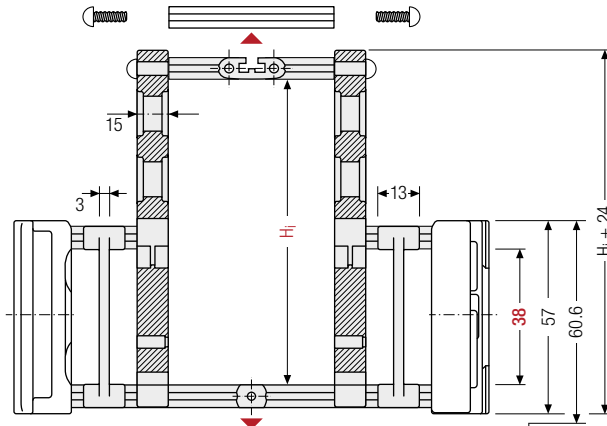

**i** The maximum cable diameter strongly depends on the bending radius and the desired cable type. Please contact us.

### Calculating the cable carrier length

#### Cable carrier length $L_k$

$$L_k \approx \frac{L_s}{2} + L_B$$

Cable carrier length  $L_k$  rounded to pitch  $t$

### **i** Intrinsic cable carrier weight

Determining the intrinsic cable carrier weight strongly depends on the selected stay arrangement. Please contact us.

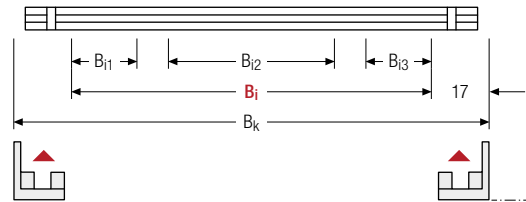

$h_i$ [mm]	$H_i$ [mm]	$h_G$ [mm]	$B_i$ [mm]	$B_{i1}$ min [mm]	$B_{i3}$ min [mm]	$B_k$ [mm]	$KR$ [mm]
38	130 160 200	57	200 – 400	16	16	$B_i + 34$	75 95 115 145 175 220 260 275 300 350

### Order example



MC0650

Type

300

$B_i$  [mm]

RMA2

Stay variant

175

$KR$  [mm]

1430

$L_k$  [mm]

HS

Stay arrangement

Assembly variants

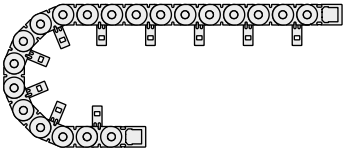

**RMA 1 – assembly to the inside:**  
 Gliding application is not possible when using assembly version RMA 1.

Observe minimum KR:  
 H<sub>i</sub> = 130 mm: KR<sub>min</sub> = 220 mm  
 H<sub>i</sub> = 160 mm: KR<sub>min</sub> = 300 mm  
 H<sub>i</sub> = 200 mm: KR<sub>min</sub> = 300 mm

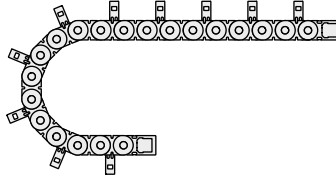

**RMA 2 – assembly to the outside:**  
 The cable carrier has to rest on the side bands and not on the stays.

Guiding in a **channel is required** for support.  
 Please contact our technical support at [technik@kabelschlepp.de](mailto:technik@kabelschlepp.de) to find the corresponding guide channel.  
 Please note the operating and installation height.



Subject to change without notice.

PROTUM® series
K series
UNIFLEX Advanced series
<b>M series</b>
TKHD series
XL series
QUANTUM® series
TKR series
TKA series
UAT series



## Plastic stay RE – screw-in frame stay

- Plastic profile bars for light to medium loads.  
Assembly without screws.
- Available customized in **8 mm grid**.
- **Outside/inside:** release by turning by 90°.



Stay arrangement on every  
2<sup>nd</sup> chain link, **standard**  
(**HS: half-stayed**)



Stay arrangement on each  
chain link (**VS: fully-stayed**)



**8 mm** B<sub>i</sub> 50 – 266 mm  
in **8 mm width sections**

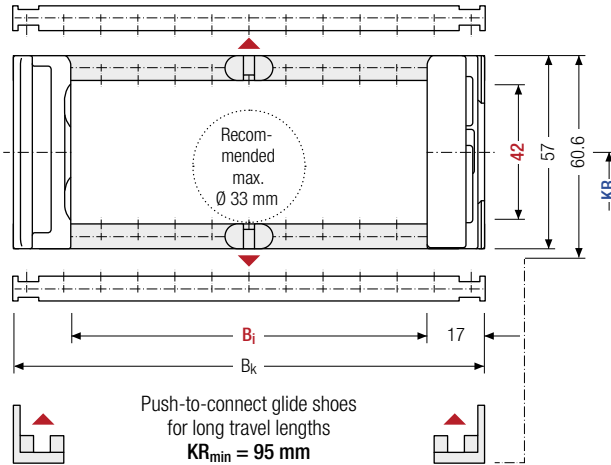

The maximum cable diameter strongly depends on the bending radius and the desired cable type. Please contact us.

For rough environmental conditions, we recommend the use of OFFROAD glide shoes with 80 % higher wear volume.

### Calculating the cable carrier length

#### Cable carrier length L<sub>k</sub>

$$L_k \approx \frac{L_S}{2} + L_B$$

Cable carrier length L<sub>k</sub>  
rounded to pitch t

TKR series	h <sub>i</sub>	h <sub>G</sub>	h <sub>G'</sub>	h <sub>G'</sub> Offroad	B <sub>i</sub>				B <sub>k</sub>	KR			q <sub>k</sub> [kg/m]		
	[mm]	[mm]	[mm]	[mm]	[mm]	[mm]	[mm]	[mm]		[mm]	[mm]	[mm]			
42	57	60.6	62.2	50	58	66	74	82	90	98	B <sub>i</sub> + 34	75	95	115	2.00
				106	114	122	130	138	146	154		145	175	220	
				162	170	178	186	194	202	210		260	275	300	2.84
				218	226	234	242	250	258	266		350			

### Order example



ME0650

Type

210

B<sub>i</sub> [mm]

RE

Stay variant

175

KR [mm]

1430

L<sub>k</sub> [mm]

HS

Stay arrangement

## Plastic stay RD – Frame stay with hinge

- Plastic profile bars with hinge for light to medium loads. Assembly without screws.
- Available customized in **8 mm grid**.
- **Outside:** swivable to both sides.
- **Inside:** release by turning by 90°.





 Stay arrangement on every 2<sup>nd</sup> chain link, **standard** (HS: half-stayed)

 Stay arrangement on each chain link (**VS: fully-stayed**)

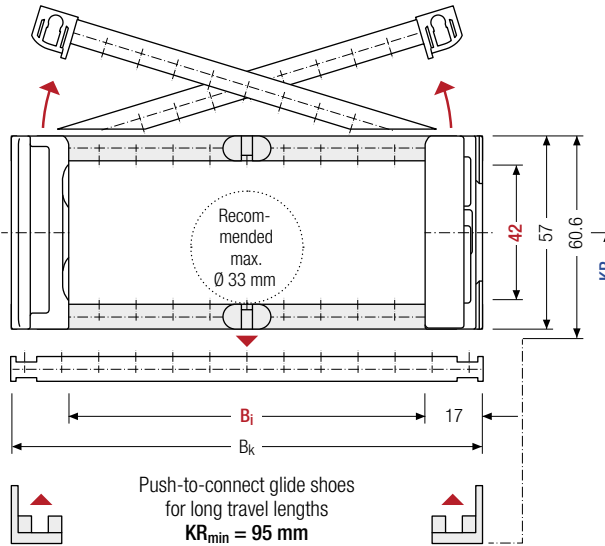
 **8 mm** B<sub>i</sub> 50 – 266 mm in 8 mm width sections



 The maximum cable diameter strongly depends on the bending radius and the desired cable type. Please contact us.

 For rough environmental conditions, we recommend the use of OFFROAD glide shoes with 80 % higher wear volume.

### Calculating the cable carrier length

**Cable carrier length L<sub>k</sub>**

$$L_k \approx \frac{L_s}{2} + L_B$$

Cable carrier length L<sub>k</sub> rounded to pitch t

h <sub>i</sub> [mm]	h <sub>g</sub> [mm]	h <sub>g'</sub> [mm]	h <sub>g'</sub> Offroad [mm]	B <sub>i</sub> [mm]						B <sub>k</sub> [mm]	KR [mm]			q <sub>k</sub> [kg/m]	
42	57	60.6	62.2	50	58	66	74	82	90	98	B <sub>i</sub> + 34	75	95	115	2.00 – 2.84
				106	114	122	130	138	146	154		145	175	220	
				162	170	178	186	194	202	210		260	275	300	
				218	226	234	242	250	258	266		350			

### Order example

MK0650 · 
 210 · 
 RD · 
 175 · 
 1430 · 
 HS  
 Type      B<sub>i</sub> [mm]      Stay variant      KR [mm]      L<sub>k</sub> [mm]      Stay arrangement

## Divider systems

As a standard, the divider system is mounted on each crossbar – for stay mounting on every 2<sup>nd</sup> chain link (HS).

As a standard, dividers and the complete divider system (dividers with height separations) can be moved in the cross section (**version A**).

The dividers are easily attached to the stay for applications with lateral acceleration and for applications laying on their side by simply turning the frame stay by 180°. The arresting cams click into place in the locking grids in the crossbars (**version B**). The groove in the frame stay faces outwards.

### Divider system TSO without height separation

Vers.	$a_T$ min [mm]	$a_x$ min [mm]	$a_c$ min [mm]	$a_x$ Raster [mm]	$n_T$ min
A	6.5	13	8.8	–	–
B	13	16	11.8	8	–

The dividers can be moved within the cross section (version A) or fixed (version B).

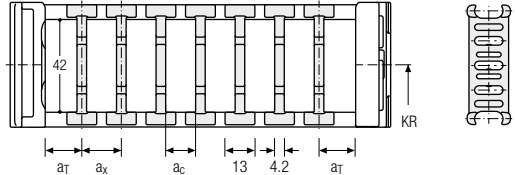

### Divider system TS1 with continuous height separation

Vers.	$a_T$ min [mm]	$a_T$ max [mm]	$a_x$ min [mm]	$a_c$ min [mm]	$a_x$ Raster [mm]	$n_T$ min
A	6.5	25	13	8.8	–	2

The dividers can be moved within the cross section.

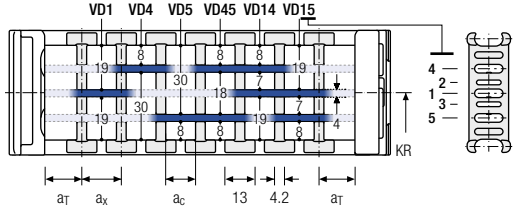

#### TOTALTRAX® complete systems

Benefit from the advantages of the TOTALTRAX® complete system. A complete delivery from one source – with a warranty certificate on request! Learn more at [tsubaki-kabelschlepp.com/totaltrax](http://tsubaki-kabelschlepp.com/totaltrax)



#### TRAXLINE® cables for cable carriers

Hi-flex electric cables which were especially developed, optimized and tested for use in cable carriers can be found at [tsubaki-kabelschlepp.com/traxline](http://tsubaki-kabelschlepp.com/traxline)

Divider system TS3 with height separation made of plastic partitions

Vers.	a <sub>T</sub> min [mm]	a <sub>x</sub> min [mm]	a <sub>c</sub> min [mm]	n <sub>T</sub> min
A	4	16 / 42*	8	2

\* For aluminum partitions

The dividers are fixed by the partitions, the complete divider system is movable in the cross section.

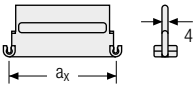
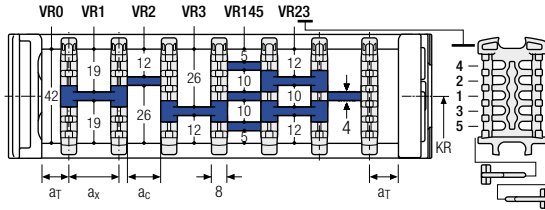

Aluminum partitions in 1 mm increments with a<sub>x</sub> > 42 mm are also available.

a <sub>x</sub> (center distance of dividers) [mm]											
a <sub>c</sub> (nominal width of inner chamber) [mm]											
16	18	23	28	32	33	38	43	48	58	64	68
8	10	15	20	24	25	30	35	40	50	56	60
78	80	88	96	112	128	144	160	176	192	208	
70	72	80	88	104	120	136	152	168	184	200	

When using plastic partitions with a<sub>x</sub> > 112 mm, we recommend an additional center support with a twin divider (S<sub>T</sub> = 3 mm). Twin dividers are also suitable for retrofitting in the partition system.

Order example

TS3

A

2

K1

34

VR1

⋮  
 ⋮  
 ⋮

K4

38

VR3

Divider system
Version
n<sub>T</sub>
Chamber
a<sub>x</sub>
Height separation

Please state the designation of the divider system (TS0, TS1 ...), version and number of dividers per cross section [n<sub>T</sub>]. In addition, please also enter the chambers [K] from left to right, as well as the assembly distances [a<sub>T</sub>/a<sub>x</sub>] (as seen from the driver).

If using divider systems with height separation (TS1, TS3) please also state the positions [e.g. VD23] viewed from the left driver belt. You are welcome to add a sketch to your order.

More product information online



Assembly instructions etc.: Additional info via your smartphone or check online at [tsubaki-kabelschlepp.com/downloads](http://tsubaki-kabelschlepp.com/downloads)



Configure your custom cable carrier: here [online-engineer.de](http://online-engineer.de)

- PROTUM® series
- K series
- UNIFLEX Advanced series
- M series
- TKHD series
- XL series
- QUANTUM® series
- TKR series
- TKA series
- UAT series

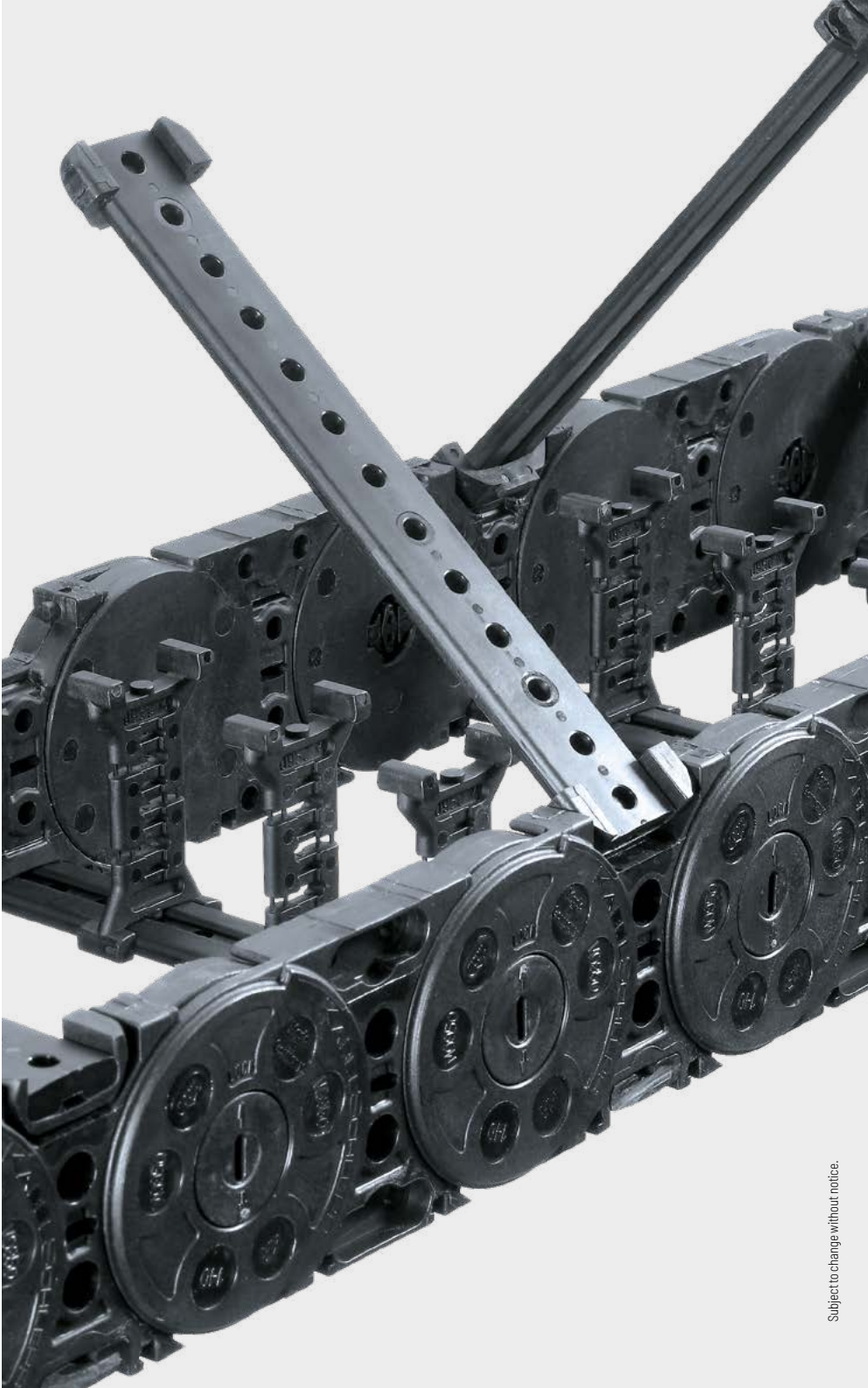
PROTUM®  
seriesK  
seriesUNIFLEX  
Advanced  
series**M**  
seriesTKHD  
seriesXL  
seriesQUANTUM®  
seriesTKR  
seriesTKA  
seriesUAT  
series

## Universal end connectors UMB – plastic (standard)

The universal mounting brackets (UMB) are made from plastic and can be mounted from the top, from the bottom, face on or from the side.

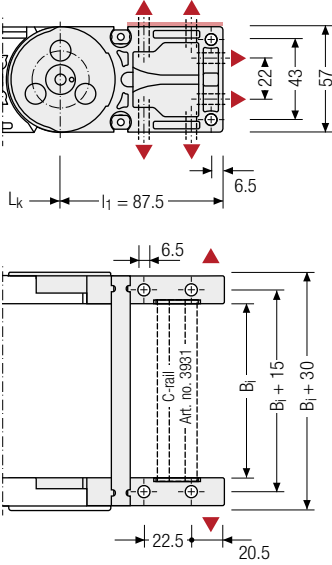

Recommended tightening torque: 11 Nm for cheese-head screws ISO 4762 - M6 - 8.8

### Connection point

- F – fixed point
- M – driver

### Connection type

- U – universal mounting bracket

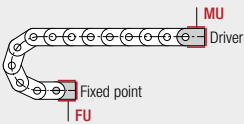

## End connectors – plastic/steel

Plastic link end connector, steel end connector. The connection variants on the fixed point and on the driver can be combined and, if required, changed afterwards.

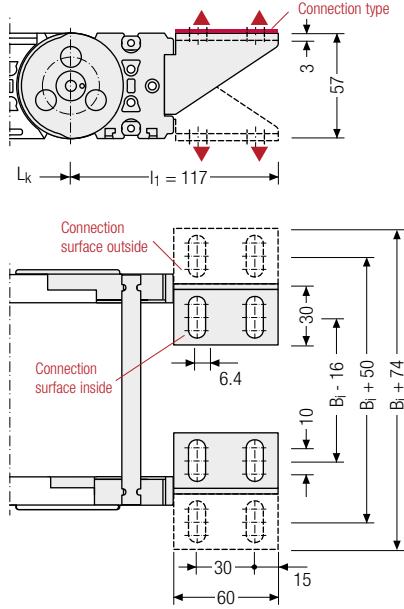

Assembly options

### Connection point

- F – fixed point
- M – driver

### Connection surface

- I – connection surface inside
- A – connection surface outside

### Connection type

- A – threaded joint outside (standard)
- I – threaded joint inside
- F – flange connection

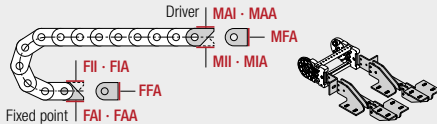

## Order example

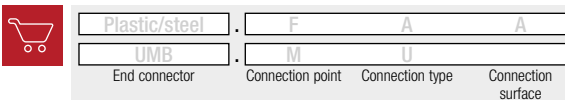

We recommend the use of strain reliefs at the driver and fixed point. See from p. 902.

PROTUM® series

K series

UNIFLEX Advanced series

M series

TKHD series

XL series

QUANTUM® series

TKR series

TKA series

UAT series

# M0950

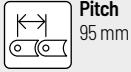

**Pitch**  
95 mm



**Inner heights**  
50 – 58 mm



**Inner widths**  
45 – 600 mm



**Bending radii**  
140 – 380 mm

## Stay variants

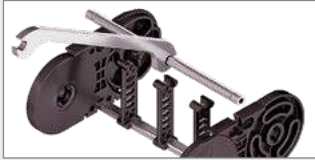

**Aluminum stay RS** ..... page **390**

### Frame stay, narrow "The standard"

- » Aluminum profile bars for light to medium loads. Assembly without screws.
- » **Outside/inside:** release by turning by 90°.



**Aluminum stay RV** ..... page **394**

### Frame stay, reinforced

- » Aluminum profile bars with plastic adapter for medium to high loads and large cable carrier widths. Assembly without screws.
- » **Outside/inside:** release by turning by 90°.

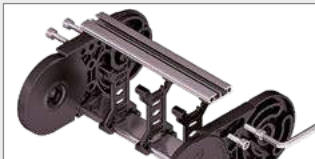

**Aluminum stay RM** ..... page **398**

### Frame stay, solid

- » Aluminum profile bars for heavy loads and maximum cable carrier widths. Double threaded joints on both sides "Heavy Duty".
- » **Inside/outside:** Threaded joint easy to release.



**Aluminum stay LG** ..... page **400**

### Hole stay, split version

- » Optimum cable routing in the neutral bending line. Split version for easy cable routing. Stays also available unsplit.
- » **Outside/inside:** Screw-fixing easy to release.

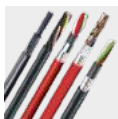

### TRAXLINE® cables for cable carriers

Hi-flex electric cables which were specially developed, optimised and tested for use in cable carriers can be found at [tsubaki-kabelschlepp.com/traxline](http://tsubaki-kabelschlepp.com/traxline).

## Stay variants



### Aluminum stay RMA ..... page 402

#### Mounting frame stay

- » Aluminum profile bars with plastic mounting frame stays for guiding very large cable diameters.
- » **Outside/inside:** Screw-fixing easy to release.



### Aluminum stay RMR ..... page 404

#### Frame rolling stay

- » Aluminum profile bars with rotating plastic rolling stay for highest requirements with gentle cable guiding. Double threaded joint on both sides.
- » **Inside/outside:** threaded joint easy to release.



### Plastic stay RE ..... page 406

#### Frame screw-in stay

- » Plastic profile bars for light to medium loads. Assembly without screws.
- » **Outside/inside:** release by turning by 90°.



### Plastic stay RD ..... page 407

#### Frame stay with hinge

- » Plastic profile bars with hinge for light to medium loads. Assembly without screws.
- » **Outside:** swivable to both sides.
- » **Inside:** release by turning by 90°.

### MT series

Also available as covered variants with cover system.  
More information can be found in chapter "MT series" from p. 610.





PROTUM®  
series

K  
series

UNIFLEX  
Advanced  
series

M  
series

TKHD  
series

XL  
series

QUANTUM®  
series

TKR  
series

TKA  
series

UAT  
series

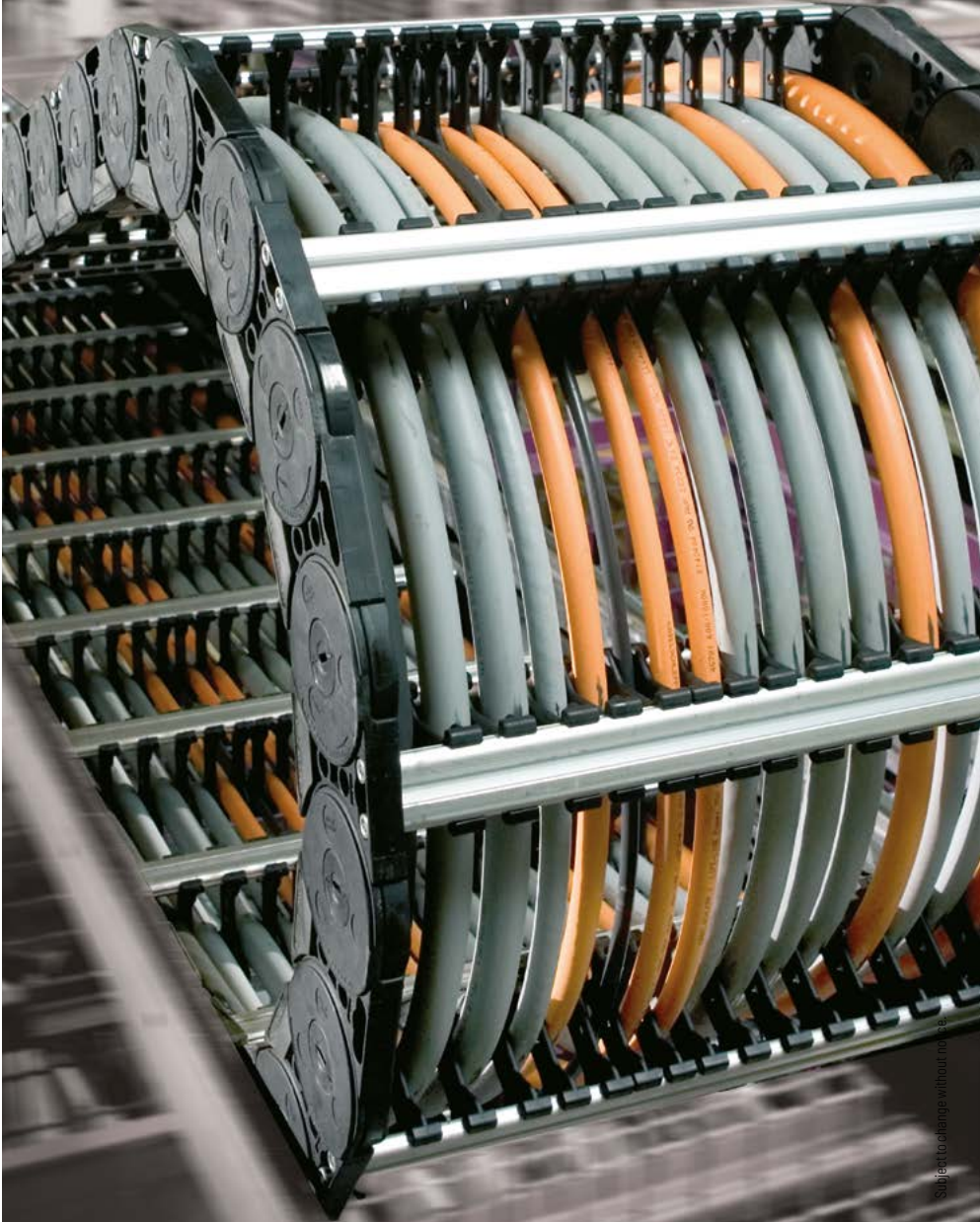

Unsupported arrangement

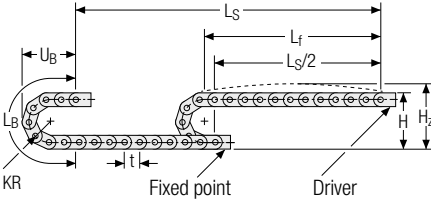

KR [mm]	H [mm]	H <sub>z</sub> [mm]	L <sub>B</sub> [mm]	U <sub>B</sub> [mm]
140	360	405	630	275
170	420	465	725	305
200	480	525	819	335
260	600	645	1007	395
290	660	705	1102	425
320	720	765	1196	445
380	840	885	1384	515

Load diagram for unsupported length depending on the additional load.

Sagging of the cable carrier is technically permitted for extended travel lengths, depending on the specific application.

Intrinsic cable carrier weight  $q_k = 4.5 \text{ kg/m}$ . For other inner widths, the maximum additional load changes.

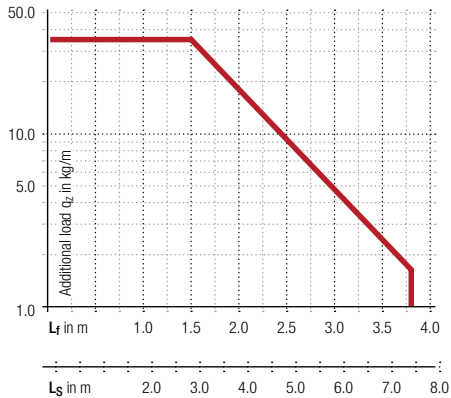

**Speed**  
up to 10 m/s

**Acceleration**  
up to 30 m/s<sup>2</sup>

**Travel length**  
up to 7.4 m

**Additional load**  
up to 35 kg/m

Gliding arrangement | GO module with chain links optimized for gliding

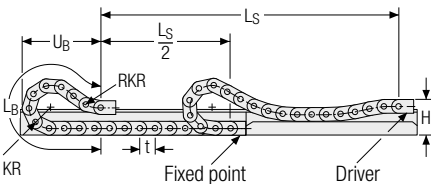

KR [mm]	H [mm]	GO module RKR [mm]	L <sub>B</sub> [mm]	U <sub>B</sub> [mm]
140	240	500	1580	740
170	240	500	1710	773
200	240	500	1995	888
260	240	500	2565	1114
290	240	500	2755	1183
320	240	500	3040	1296
380	240	500	3610	1523

**Speed**  
up to 8 m/s

**Acceleration**  
up to 20 m/s<sup>2</sup>

**Travel length**  
up to 260 m

**Additional load**  
up to 35 kg/m

The gliding cable carrier must be guided in a channel. See p. 842.

The GO module mounted on the driver is a defined sequence of 4 adapted KR/RKR link plates.

Gliding shoes have to be used for gliding applications.



Our technical support can provide help for gliding arrangements:  
[technik@kabelschlepp.de](mailto:technik@kabelschlepp.de)

PROTUM® series
K series
UNIFLEX Advanced series
M series
TKHD series
XL series
QUANTUM® series
TKR series
TKA series
UAT series

## Aluminum stay RS – frame stay narrow

- Extremely quick to open and close
- Aluminum profile bars for light to medium loads.  
Assembly without screws.
- Available customized in **1 mm grid**.
- **Outside/inside:** release by turning by 90°.

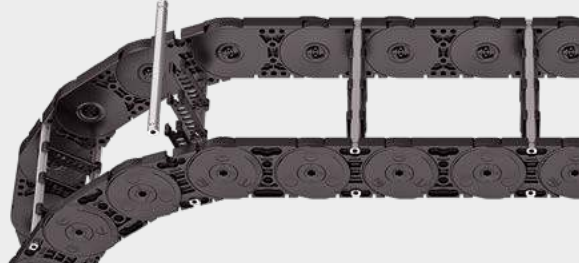

Stay arrangement on every  
2<sup>nd</sup> chain link, **standard**  
(HS: half-stayed)



Stay arrangement on each  
chain link (**VS: fully-stayed**)



**1 mm** B<sub>i</sub> 75 – 400 mm  
in **1 mm width sections**

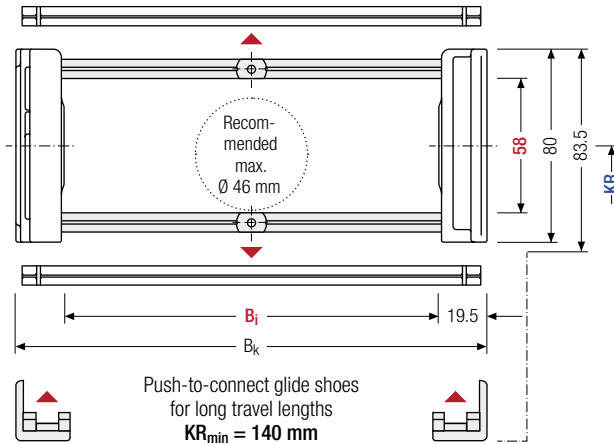

The maximum cable diameter strongly depends on the bending radius and the desired cable type. Please contact us.



For rough environmental conditions, we recommend the use of OFFROAD glide shoes with 80 % higher wear volume.

### Calculating the cable carrier length

#### Cable carrier length L<sub>k</sub>

$$L_k \approx \frac{L_s}{2} + L_B$$

Cable carrier length L<sub>k</sub>  
rounded to pitch t

h <sub>i</sub> [mm]	h <sub>G</sub> [mm]	h <sub>G'</sub> [mm]	h <sub>G'</sub> Offroad [mm]	B <sub>i</sub> [mm]*	B <sub>k</sub> [mm]	KR [mm]				q <sub>k</sub> [kg/m]			
58	80	83.5	86	75 – 400	B <sub>i</sub> + 39	140	170	200	260	290	320	380	2.93 – 4.71

\* in 1 mm width sections

### Order example



MC0950

Type

400

B<sub>i</sub> [mm]

RS

Stay variant

200

KR [mm]

2850

L<sub>k</sub> [mm]

HS

Stay arrangement

### Divider systems

As a standard, the divider system is mounted on each crossbar – for stay mounting on every 2<sup>nd</sup> chain link (HS).

As a standard, dividers and the complete divider system (dividers with height separations) can be moved in the cross section (**version A**).

For applications with lateral acceleration and rotated by 90°, the dividers can be attached by simply clipping on a socket (available as an accessory).

The socket additionally serves as a spacer between the dividers and is available in 1 mm sections between 3 – 50 mm. The inner height is reduced to 54 mm (**version B**).

### Divider system TSO without height separation

Vers.	a <sub>T</sub> min [mm]	a <sub>x</sub> min [mm]	a <sub>c</sub> min [mm]	π <sub>T</sub> min
A	4.5	14	10	2

The dividers can be moved in the cross section.

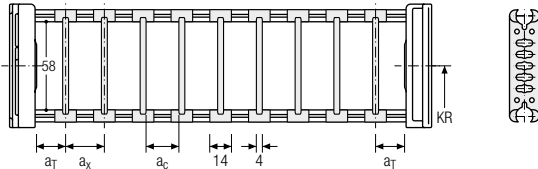

### Divider system TS1 with continuous height separation

Vers.	a <sub>T</sub> min [mm]	a <sub>T</sub> max [mm]	a <sub>x</sub> min [mm]	a <sub>c</sub> min [mm]	π <sub>T</sub> min
A	4.5	25	14	10	2

The dividers can be moved in the cross section.

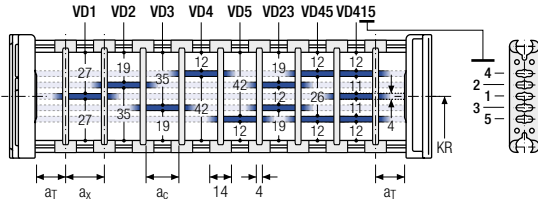

### Divider system TS2 with partial height separation

Vers.	a <sub>T</sub> min [mm]	a <sub>x</sub> min [mm]	a <sub>c</sub> min [mm]	π <sub>T</sub> min
A	4.5	23	19	2

With grid distribution (1 mm grid). The dividers are attached by the height separation, the grid can be moved in the cross section. Sliding dividers are optionally available (thickness of divider = 4 mm).

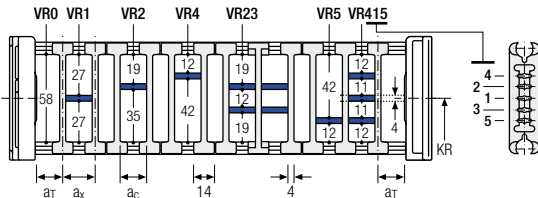

Please note that the real dimensions may deviate slightly from the values indicated here.

### Order example

**TS2** . **A** . **3** . **K1** . **34** - **VR1**

⋮ ⋮ ⋮

**K4** . **38** - **VR3**

Divider system      Version      π<sub>T</sub>      Chamber      a<sub>x</sub>      Height separation

PROTUM® series
K series
UNIFLEX Advanced series
<b>M series</b>
TKHD series
XL series
QUANTUM® series
TKR series
TKA series
UAT series

## Divider system TS3 with height separation consisting of plastic partitions

As a standard, the divider **version A** is used for vertical partitioning within the cable carrier. The complete divider system can be moved within the cross section.

PROTUM® series

K series

UNIFLEX Advanced series

M series

TKHD series

XL series

QUANTUM® series

TKR series

TKA series

UAT series

Divider version A

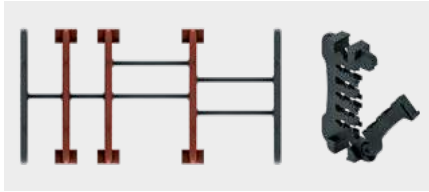

End divider

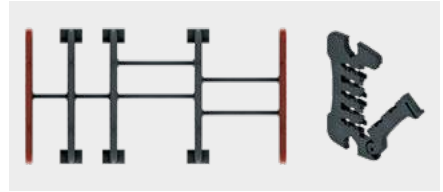

Vers.	a <sub>T</sub> min [mm]	a <sub>x</sub> min [mm]	a <sub>c</sub> min [mm]	n <sub>T</sub> min
A	6/2*	14	10	2

\* For End divider

The dividers are fixed by the partitions, the complete divider system is movable in the cross section.

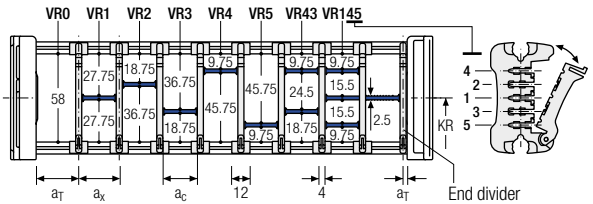

a <sub>x</sub> (center distance of dividers) [mm]																
a <sub>c</sub> (nominal width of inner chamber) [mm]																
14	16	19	23	24	28	29	32	33	34	38	39	43	44	48	49	54
10	12	15	19	20	24	25	28	29	30	34	35	39	40	44	45	50
58	59	64	68	69	74	78	79	80	84	88	89	94	96	99	112	
54	55	60	64	65	70	74	75	76	80	84	85	90	92	95	108	

When using partitions with a<sub>x</sub> > 49 mm we recommended an additional preferential central support.

### Order example

TS3

A

3

K1

34

VR1

K4

38

VR3

Divider system

Version

n<sub>T</sub>

Chamber

a<sub>x</sub>

Height separation

Please state the designation of the divider system (TS0, TS1,...), version and number of dividers per cross section [n<sub>T</sub>]. In addition, please also enter the chambers [K] from left to right, as well as the assembly distances [a<sub>T</sub>/a<sub>x</sub>] (as seen from the driver).

If using divider systems with height separation (TS1, TS3) please also state the positions [e.g. VD23] viewed from the left driver belt. You are welcome to add a sketch to your order.



PROTUM®  
series

K  
series

UNIFLEX  
Advanced  
series

**M**  
series

TKHD  
series

XL  
series

QUANTUM®  
series

TKR  
series

TKA  
series

UAT  
series

## Aluminum stay RV – frame stay reinforced

- Aluminum profile bars with plastic adapter for medium to high loads and large cable carrier widths. Assembly without screws.
- Available customized in **1 mm grid**.
- **Outside/inside:** release by turning by 90°.

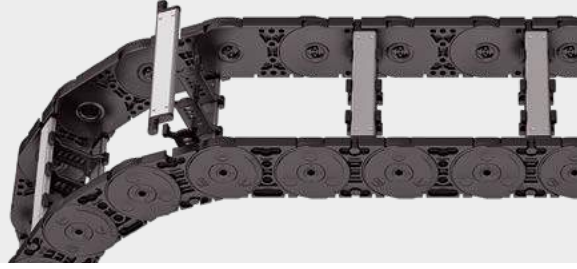

Stay arrangement on every 2<sup>nd</sup> chain link, **standard** (HS: half-stayed)



Stay arrangement on each chain link (**VS: fully-stayed**)



**1 mm** B<sub>i</sub> 75 – 500 mm in **1 mm width sections**

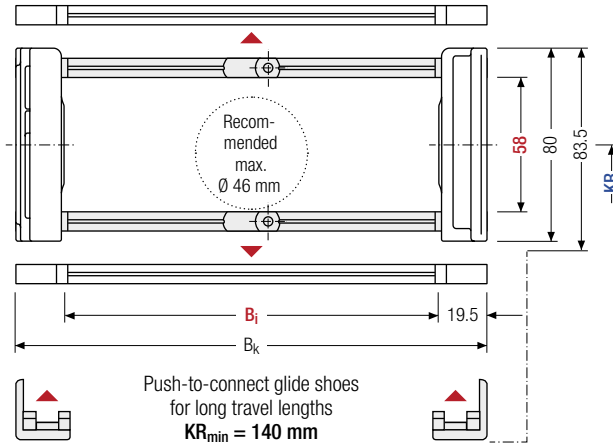

The maximum cable diameter strongly depends on the bending radius and the desired cable type. Please contact us.

For rough environmental conditions, we recommend the use of OFFROAD glide shoes with 80 % higher wear volume.

### Calculating the cable carrier length

#### Cable carrier length $L_k$

$$L_k \approx \frac{L_s}{2} + L_B$$

Cable carrier length  $L_k$  rounded to pitch  $t$

$h_i$ [mm]	$h_G$ [mm]	$h_G'$ [mm]	$h_G'$ Offroad [mm]	B <sub>i</sub> [mm]*	B <sub>k</sub> [mm]	KR [mm]				q <sub>k</sub> [kg/m]			
58	80	83.5	86	75 – 500	B <sub>i</sub> + 39	140	170	200	260	290	320	380	3.32 – 6.02

\* in 1 mm width sections

### Order example



MC0950

Type

400

B<sub>i</sub> [mm]

RV

Stay variant

200

KR [mm]

2850

L<sub>k</sub> [mm]

HS

Stay arrangement

**Divider systems**

As a standard, the divider system is mounted on each crossbar – for stay mounting on every 2<sup>nd</sup> chain link (HS).

As a standard, dividers and the complete divider system (dividers with height separations) can be moved in the cross section (**version A**).

**Divider system TSO without height separation**

Vers.	a <sub>T</sub> min [mm]	a <sub>x</sub> min [mm]	a <sub>c</sub> min [mm]	n <sub>T</sub> min
A	4.5	14	10	2

The dividers can be moved in the cross section.

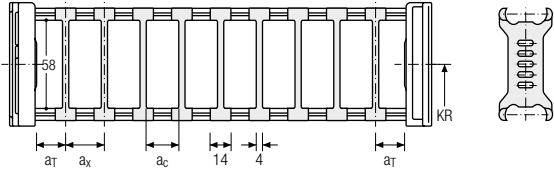

**Divider system TS1 with continuous height separation**

Vers.	a <sub>T</sub> min [mm]	a <sub>T</sub> max [mm]	a <sub>x</sub> min [mm]	a <sub>c</sub> min [mm]	n <sub>T</sub> min
A	4.5	25	14	10	2

The dividers can be moved in the cross section.

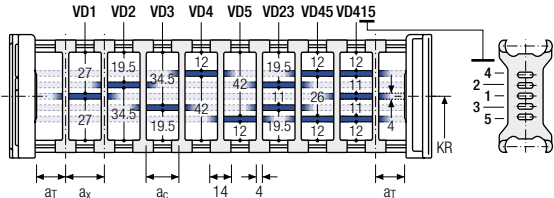

**Divider system TS2 with partial height separation**

Vers.	a <sub>T</sub> min [mm]	a <sub>x</sub> min [mm]	a <sub>c</sub> min [mm]	n <sub>T</sub> min
A	5.5	21	15	2

With grid distribution (1 mm grid). The dividers are attached by the height separation, the grid can be moved in the cross section.

Sliding dividers are optionally available (thickness of divider = 4 mm).

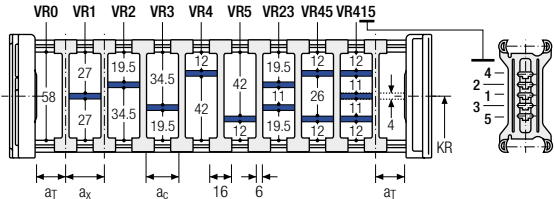

PROTUM® series

K series

UNIFLEX Advanced series

M series

TKHD series

XL series

QUANTUM® series

TKR series

TKA series

UAT series

Subject to change without notice.



**TOTALTRAX® complete systems**

Benefit from the advantages of the TOTALTRAX® complete system. A complete delivery from one source – with a warranty certificate on request! Learn more at [tsubaki-kabelschlepp.com/totaltrax](http://tsubaki-kabelschlepp.com/totaltrax)



**TRAXLINE® cables for cable carriers**

Hi-flex electric cables which were especially developed, optimized and tested for use in cable carriers can be found at [tsubaki-kabelschlepp.com/traxline](http://tsubaki-kabelschlepp.com/traxline)



## Divider system TS3 with height separation made of plastic partitions

Vers.	$a_T$ min [mm]	$a_x$ min [mm]	$a_c$ min [mm]	$n_T$ min
A	4	16 / 42	8	2

\* For aluminum partitions

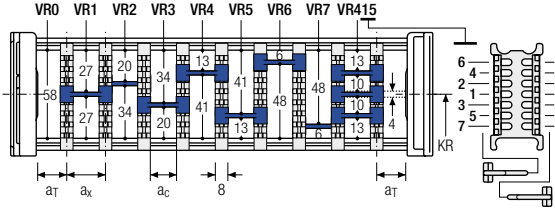

The dividers are fixed by the partitions, the complete divider system is movable in the cross section.

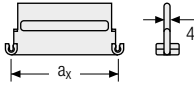

Aluminum partitions in 1 mm increments with  $a_x > 42$  mm are also available.

$a_x$ (center distance of dividers) [mm]											
$a_c$ (nominal width of inner chamber) [mm]											
16	18	23	28	32	33	38	43	48	58	64	68
8	10	15	20	24	25	30	35	40	50	56	60
78	80	88	96	112	128	144	160	176	192	208	
70	72	80	88	104	120	136	152	168	184	200	

When using **plastic partitions with  $a_x > 112$  mm**, we recommend an additional center support with a **twin divider** ( $S_T = 4$  mm). Twin dividers are also suitable for retrofitting in the partition system.

### Order example

	TS3	A	3	K1	34	VR1
				⋮	⋮	⋮
			K4	38	VR3	
	Divider system	Version	$n_T$	Chamber	$a_x$	Height separation

Please state the designation of the divider system (TS0, TS1 ...), version and number of dividers per cross section  $[n_T]$ . In addition, please also enter the chambers [K] from left to right, as well as the assembly distances  $[a_T/a_x]$  (as seen from the driver).

If using divider systems with height separation (TS1, TS3) please also state the positions [e.g. VD23] viewed from the left driver belt. You are welcome to add a sketch to your order.

### More product information online



Assembly instructions etc.:  
Additional info via your  
smartphone or check online at  
[tsubaki-kabelschlepp.com/  
downloads](https://tsubaki-kabelschlepp.com/downloads)



Configure your custom  
cable carrier here:  
**online-engineer.de**

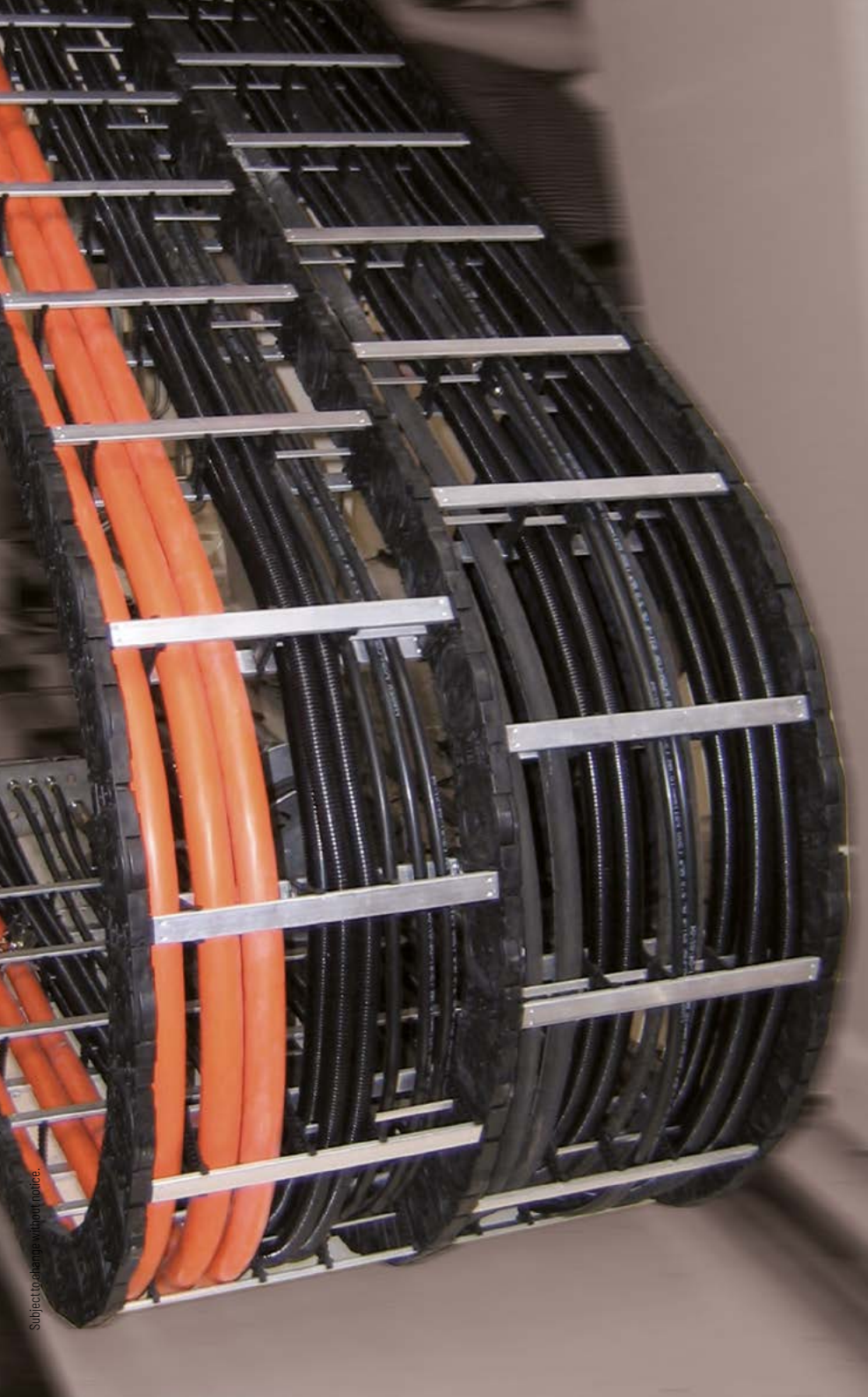

Subject to change without notice.

PROTUM®  
series

K  
series

UNIFLEX  
Advanced  
series

**M**  
series

TKHD  
series

XL  
series

QUANTUM®  
series

TKR  
series

TKA  
series

UAT  
series

## Aluminum stay RM – frame stay solid

- Aluminum profile bars for heavy loads and maximum cable carrier widths. Double threaded joints on both sides “**Heavy Duty**”.
- Available customized in **1 mm grid**.
- **Inside/outside:** Threaded joint easy to release.

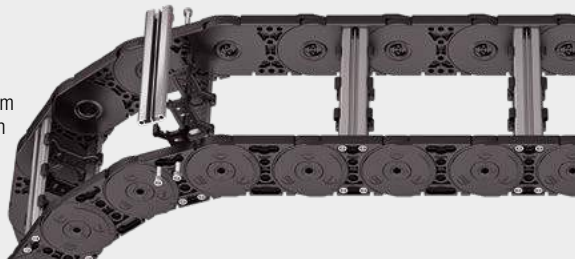

Stay arrangement on every 2<sup>nd</sup> chain link, **standard** (HS: half-stayed)



Stay arrangement on each chain link (**VS: fully-stayed**)



**1 mm** B<sub>i</sub> 75 – 600 mm in **1 mm width sections**

PROTUN® series

K series

UNIFLEX Advanced series

M series

TKHD series

XL series

QUANTUM® series

TKR series

TKA series

UAT series

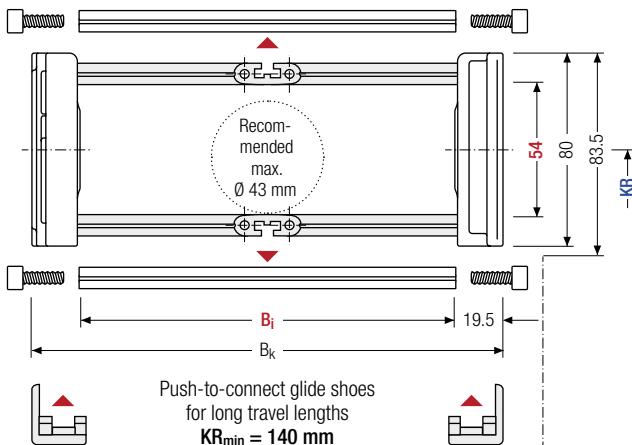

The maximum cable diameter strongly depends on the bending radius and the desired cable type. Please contact us.

For rough environmental conditions, we recommend the use of OFFROAD glide shoes with 80 % higher wear volume.

### Calculating the cable carrier length

**Cable carrier length L<sub>k</sub>**

$$L_k \approx \frac{L_s}{2} + L_B$$

Cable carrier length L<sub>k</sub> rounded to pitch t

h <sub>i</sub> [mm]	h <sub>G</sub> [mm]	h <sub>G'</sub> [mm]	h <sub>G'</sub> Offroad [mm]	B <sub>i</sub> [mm]*	B <sub>k</sub> [mm]	KR [mm]						q <sub>k</sub> [kg/m]	
54	80	83.5	86	75 – 600	B <sub>i</sub> + 39	140	170	200	260	290	320	380	3.63 – 6.55

\* in 1 mm width sections

### Order example

MC0950 · 
 400 · 
 RM · 
 200 · 
 2850 · 
 HS  
 Type · B<sub>i</sub> [mm] · Stay variant · KR [mm] · L<sub>k</sub> [mm] · Stay arrangement

**Divider systems**

As a standard, the divider system is mounted on each crossbar – for stay mounting on every 2<sup>nd</sup> chain link (HS).

As a standard, dividers and the complete divider system (dividers with height separations) can be moved in the cross section (**version A**).

**Divider system TSO without height separation**

Vers.	a <sub>T</sub> min [mm]	a <sub>x</sub> min [mm]	a <sub>c</sub> min [mm]	n <sub>T</sub> min
A	4.5	14	10	–

The dividers can be moved in the cross section.

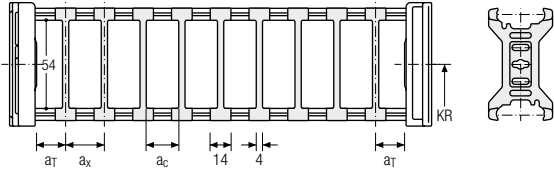

**Divider system TS1 with continuous height separation**

Vers.	a <sub>T</sub> min [mm]	a <sub>T</sub> max [mm]	a <sub>x</sub> min [mm]	a <sub>c</sub> min [mm]	n <sub>T</sub> min
A	3.5	25	12	8	2

The dividers can be moved in the cross section.

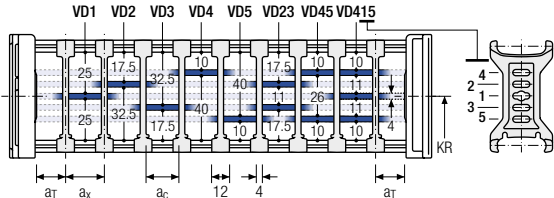

**Divider system TS2 with partial height separation**

Vers.	a <sub>T</sub> min [mm]	a <sub>x</sub> min [mm]	a <sub>c</sub> min [mm]	n <sub>T</sub> min
A	4.5	21	15	2

With grid distribution (1 mm grid). The dividers are attached by the height separation, the grid can be moved in the cross section.

Sliding dividers are optionally available (thickness of divider = 4 mm).

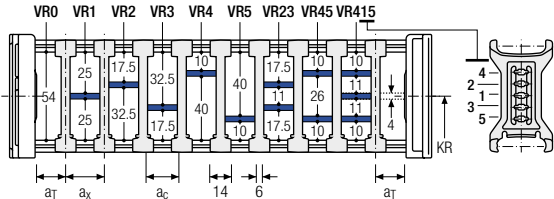

**Order example**

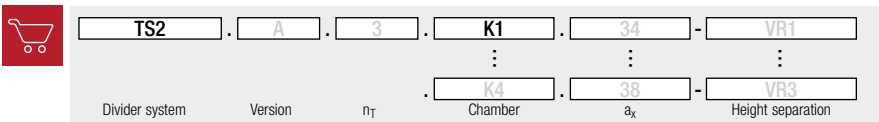

Please state the designation of the divider system (TS0, TS1 ...), version and number of dividers per cross section [n<sub>T</sub>]. In addition, please also enter the chambers [K] from left to right, as well as the assembly distances [a<sub>T</sub>/a<sub>x</sub>] (as seen from the driver).

If using divider systems with height separation (TS1, TS2) please also state the positions [e.g. VD23] viewed from the left driver belt. You are welcome to add a sketch to your order.

- PROTUM® series
- K series
- UNIFLEX Advanced series
- M series
- TKHD series
- XL series
- QUANTUM® series
- TKR series
- TKA series
- UAT series

## Aluminum stay LG – Hole stay, split version

- Optimum cable routing in the neutral bending line. Split version for easy cable routing. Stays also available unsplit.
- Available customized in **1 mm width sections**.
- **Outside/inside:** Screw-fixing easy to release.



Stay arrangement on every 2<sup>nd</sup> chain link, **standard** (HS: half-stayed)



Stay arrangement on each chain link (VS: fully-stayed)



**1 mm**  $B_i$  75 – 600 mm in **1 mm width sections**

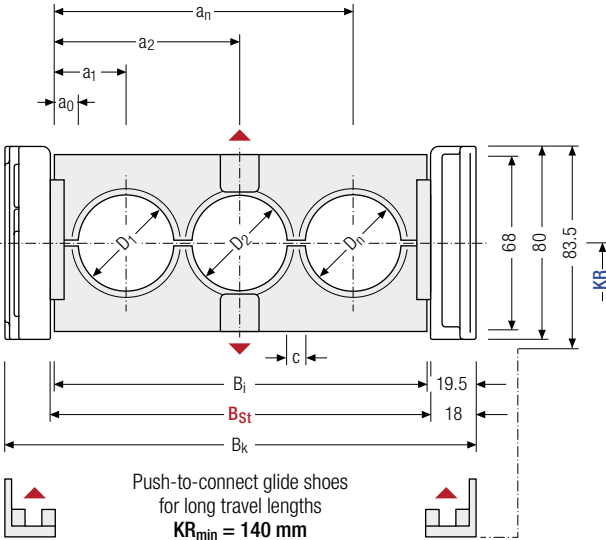

The maximum cable diameter strongly depends on the bending radius and the desired cable type. Please contact us.

### Calculating the cable carrier length

#### Cable carrier length $L_k$

$$L_k \approx \frac{L_s}{2} + L_B$$

Cable carrier length  $L_k$  rounded to pitch  $t$

### Calculating the stay width

#### Stay width $B_{St}$

$$B_{St} = \sum D + \sum c + 2 a_0$$

$D_{max}$ [mm]	$D_{min}$ [mm]	$h_G$ [mm]	$B_i$ [mm]	$B_{St}$ [mm]*	$B_k$ [mm]	$c_{min}$ [mm]	$a_0$ min [mm]	KR [mm]				$q_k$ 50 %** [kg/m]
50	12	80	75 – 600	78 – 603	$B_{St} + 39$	4	11	140	170	200	260	3.89 – 8.25
								290	320	380		

\* in 1 mm width sections

\*\* Hole ratio of the hole stay approx. 50 %

### Order example



MC0950

Type

400

$B_i$  [mm]

LG

Stay variant

200

KR [mm]

2850

$L_k$  [mm]

HS

Stay arrangement

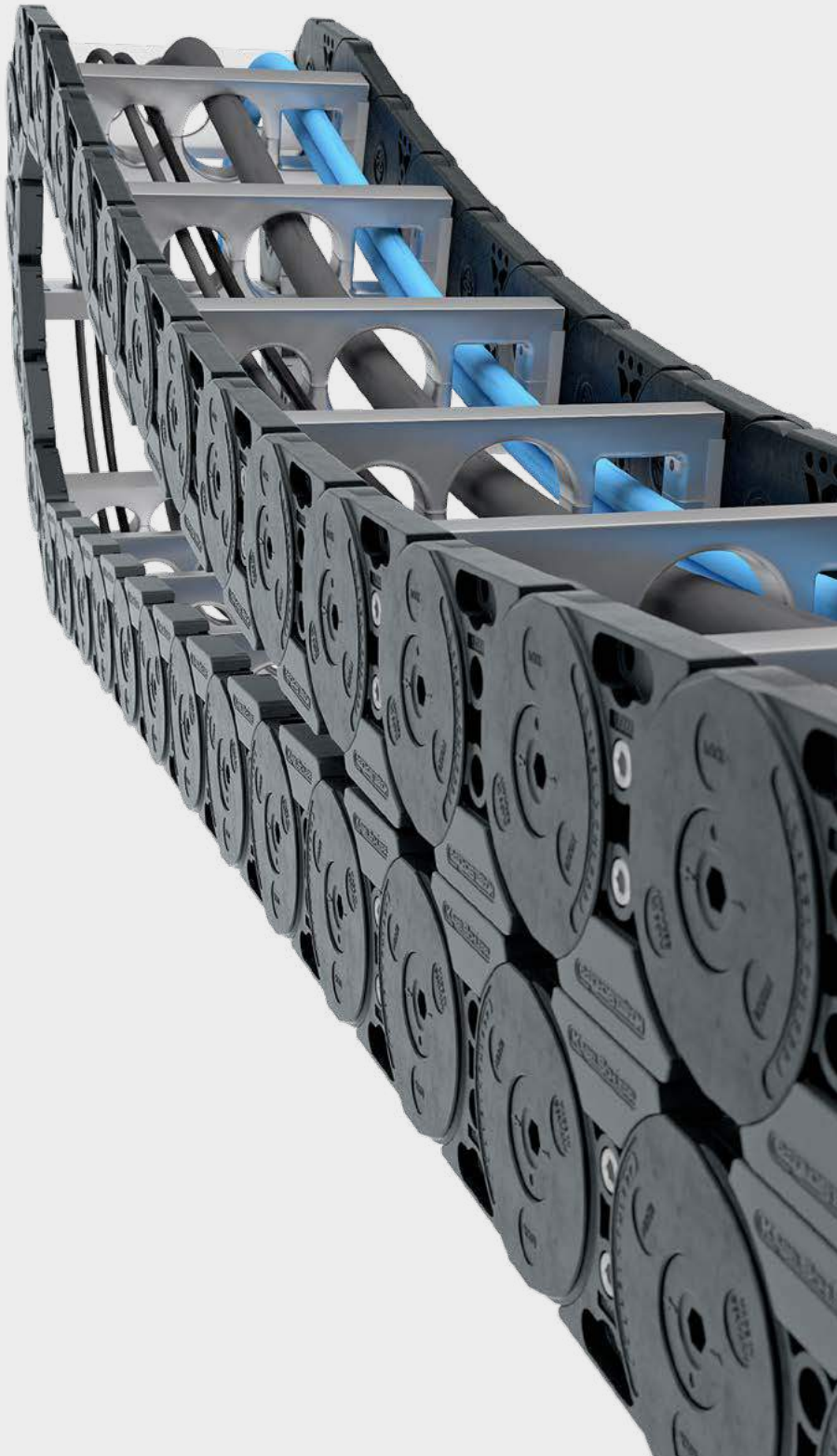

PROTUM®  
series

K  
series

UNIFLEX  
Advanced  
series

**M**  
series

TKHD  
series

XL  
series

QUANTUM®  
series

TKR  
series

TKA  
series

UAT  
series

# Aluminum stay RMA – mounting frame stay

- Aluminum profile bars with plastic mounting frame stays for guiding very large cable diameters.
- The mounting frame stay can be mounted either inside or outside in the bending radius. Available customized in **1 mm width sections**.
- **Outside/inside:** Screw-fixing easy to release.

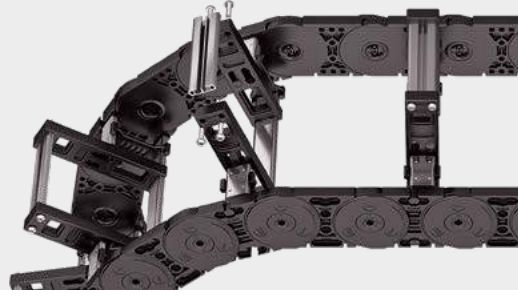

 Stay arrangement on every 2<sup>nd</sup> chain link, **standard (HS: half-stayed)**

 Stay arrangement on each chain link (**VS: fully-stayed**)

 **1 mm** B<sub>i</sub> 200 – 500 mm in **1 mm width sections**

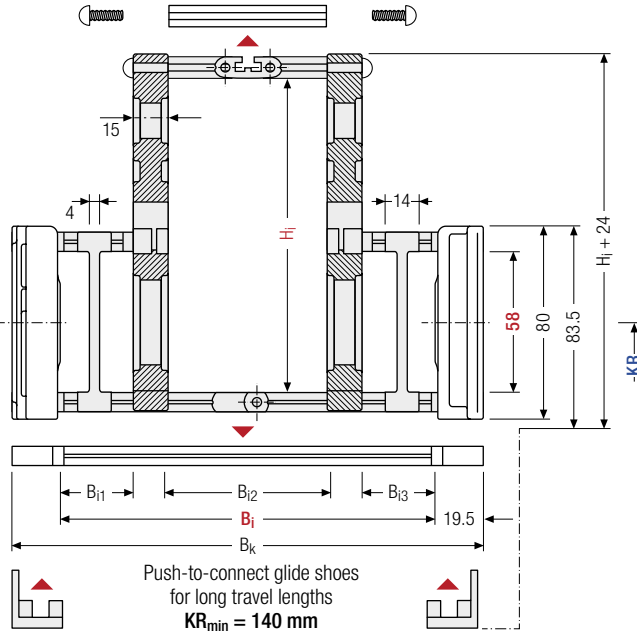

 The maximum cable diameter strongly depends on the bending radius and the desired cable type. Please contact us.

### Calculating the cable carrier length

#### Cable carrier length L<sub>k</sub>

$$L_k \approx \frac{L_s}{2} + L_B$$

Cable carrier length L<sub>k</sub> rounded to pitch t

### Intrinsic cable carrier weight

Determining the intrinsic cable carrier weight strongly depends on the selected stay arrangement. Please contact us.

h <sub>i</sub> [mm]	H <sub>i</sub> [mm]	h <sub>G</sub> [mm]	B <sub>i</sub> [mm]	B <sub>i1</sub> min [mm]	B <sub>i3</sub> min [mm]	B <sub>k</sub> [mm]	KR [mm]
58	130 160	80	200 – 500	40	40	B <sub>i</sub> + 39	140 170 200 260
	200						290 320 380

### Order example

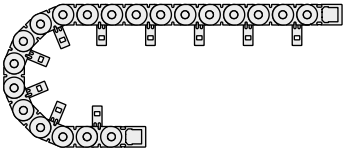

MC0950 Type · 
 400 B<sub>i</sub> [mm] · 
 RMA2 Stay variant · 
 200 KR [mm] · 
 2850 L<sub>k</sub> [mm] · 
 HS Stay arrangement

Assembly variants

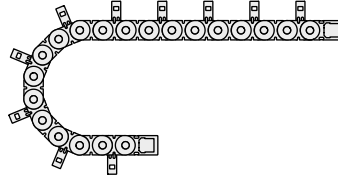

**RMA 1 – assembly to the inside:**  
 Gliding application is not possible when using assembly version RMA 1.

Observe minimum KR:  
 H<sub>i</sub> = 130 mm: KR<sub>min</sub> = 170 mm  
 H<sub>i</sub> = 160 mm: KR<sub>min</sub> = 200 mm  
 H<sub>i</sub> = 200 mm: KR<sub>min</sub> = 260 mm



**RMA 2 – assembly to the outside:**  
 The cable carrier has to rest on the side bands and not on the stays.

Guiding in a **channel is required** for support.  
 Please contact our technical support at [technik@kabelschlepp.de](mailto:technik@kabelschlepp.de) to find the corresponding guide channel.  
 Please note the operating and installation height.

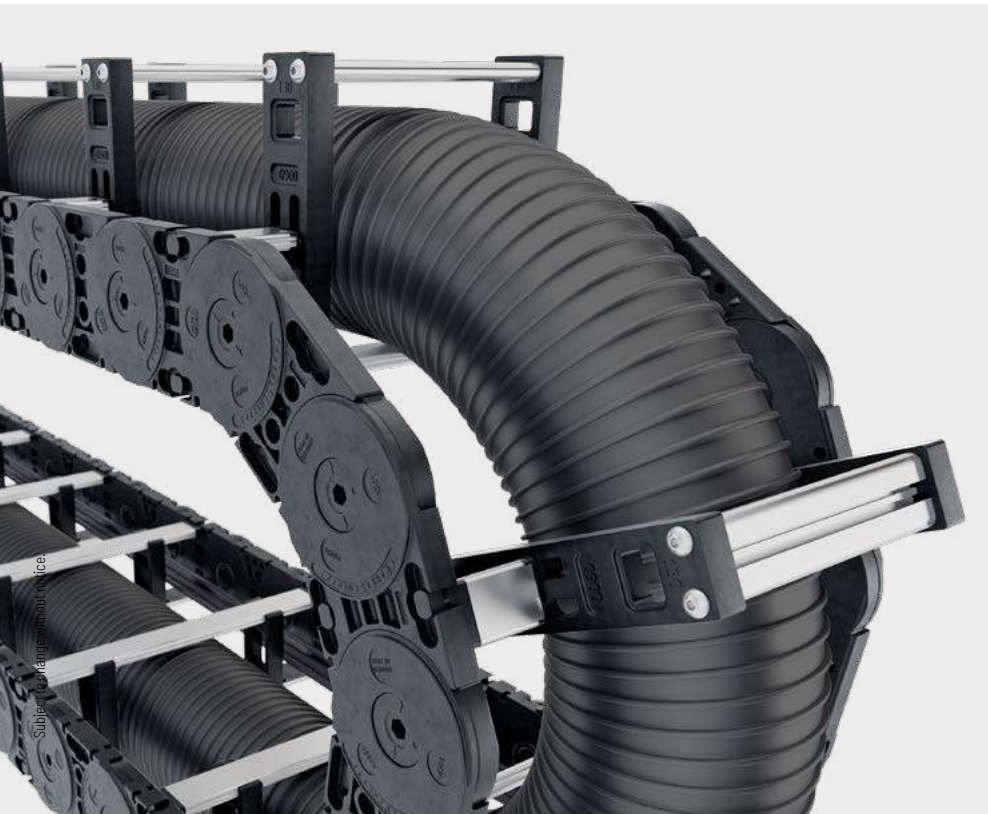

Subject to change without notice

PROTUM® series
K series
UNIFLEX Advanced series
<b>M series</b>
TKHD series
XL series
QUANTUM® series
TKR series
TKA series
UAT series



## Aluminum stay RMR – Frame rolling stay

- Aluminum profile bars with rotating plastic rolling stay for highest requirements with gentle cable guiding. Double threaded joint on both sides.
- Available customized in **1 mm grid**.
- **Inside/outside:** Threaded joint easy to release.

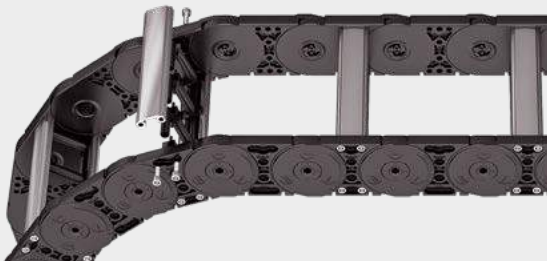

Stay arrangement on every 2<sup>nd</sup> chain link, **standard** (HS: half-stayed)



Stay arrangement on each chain link (**VS: fully-stayed**)



**1 mm**  $B_i$  75 – 600 mm in **1 mm width sections**

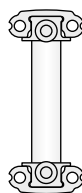
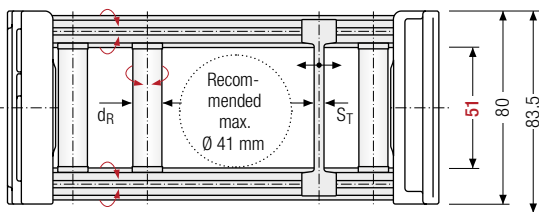

Calculating the cable carrier length

Cable carrier length  $L_k$

$$L_k \approx \frac{L_s}{2} + L_B$$

Cable carrier length  $L_k$  rounded to pitch  $t$

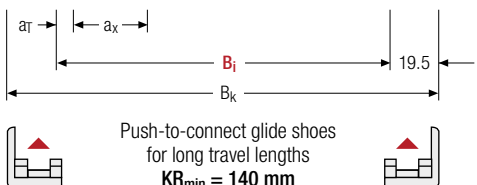

The maximum cable diameter strongly depends on the bending radius and the desired cable type. Please contact us.



For rough environmental conditions, we recommend the use of OFFROAD glide shoes with 80 % higher wear volume.

$h_i$ [mm]	$h_g$ [mm]	$h_g'$ [mm]	$h_g'$ Offroad [mm]	$B_i$ [mm]*	$B_k$ [mm]	$d_R$ [mm]	$S_T$ [mm]	$a_T$ min [mm]	$a_x$ min [mm]	$KR$ [mm]	$q_k$ [kg/m]
51	80	83.5	86	75 – 600	$B_i + 39$	10	4	6.5	37	140	3.63
										170	–
										200	6.55
										260	–
										290	–
										320	–
										380	6.55

\* in 1 mm width sections

### Order example

	<b>MC0950</b> Type	·	<b>400</b> $B_i$ [mm]	·	<b>RMR</b> Stay variant	·	<b>200</b> $KR$ [mm]	·	<b>2850</b> $L_k$ [mm]	·	<b>HS</b> Stay arrangement
--	-----------------------	---	--------------------------	---	----------------------------	---	-------------------------	---	---------------------------	---	-------------------------------

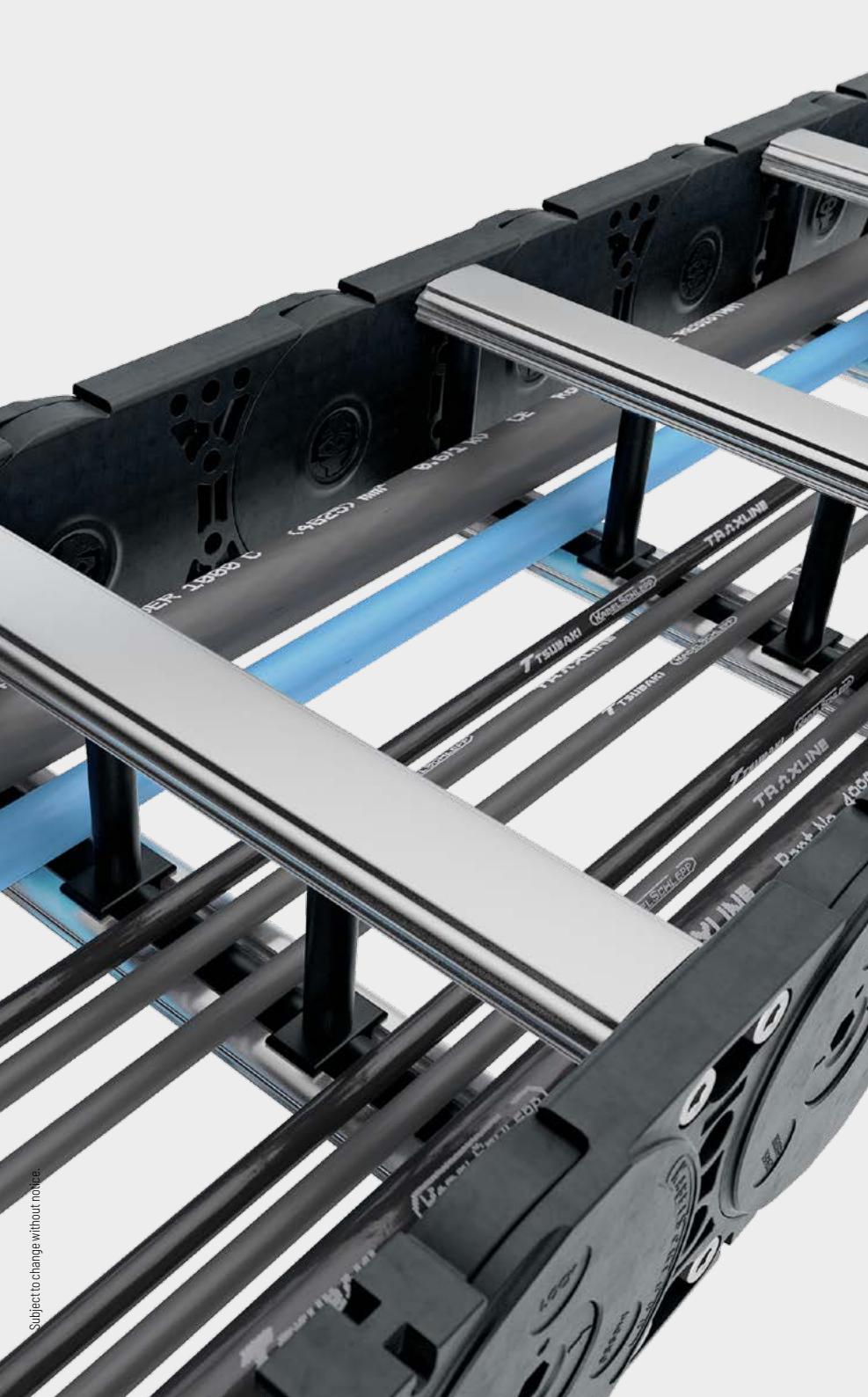

Subject to change without notice.

PROTUM®  
series

K  
series

UNIFLEX  
Advanced  
series

**M**  
series

TKHD  
series

XL  
series

QUANTUM®  
series

TKR  
series

TKA  
series

UAT  
series

## Plastic stay RE – screw-in frame stay

- Plastic profile bars for light to medium loads.  
Assembly without screws.
- Available customized in **16 mm grid**.
- **Outside/inside:** release by turning by 90°.



Stay arrangement on every  
2<sup>nd</sup> chain link, **standard**  
(HS: half-stayed)



Stay arrangement on each  
chain link (VS: fully-stayed)



**16 mm** B<sub>i</sub> 45 – 557 mm  
in **16 mm** width sections

M series

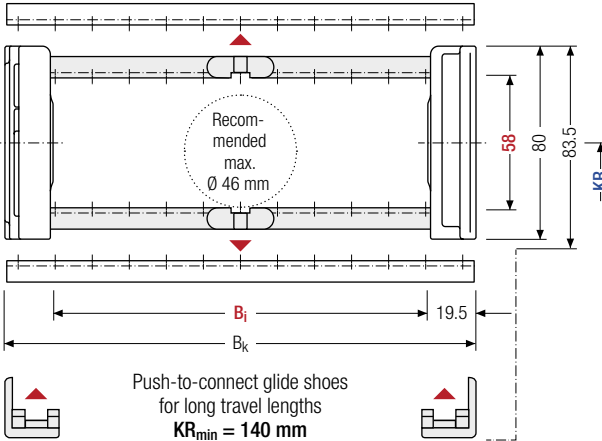

The maximum cable diameter strongly depends on the bending radius and the desired cable type. Please contact us.

For rough environmental conditions, we recommend the use of OFFROAD glide shoes with 80 % higher wear volume.

### Calculating the cable carrier length

Cable carrier length L<sub>k</sub>

$$L_k \approx \frac{L_s}{2} + L_B$$

Cable carrier length L<sub>k</sub>  
rounded to pitch t

TKR series	h <sub>i</sub>	h <sub>G</sub>	h <sub>G'</sub>	h <sub>G'</sub> Offroad	B <sub>i</sub>						B <sub>k</sub>	KR		q <sub>k</sub>		
	[mm]	[mm]	[mm]	[mm]	[mm]	[mm]	[mm]	[mm]	[mm]	[mm]		[mm]	[mm]		[mm]	
58	80	83.5	86	45	61	77	93	109	125	141	157	173	B <sub>i</sub> + 39	140	170	3.0
				189	205	221	237	253	269	285	301	317		200	260	
				333	349	365	381	397	413	429	445	461		290	320	6.2
				477	493	509	525	541	557					380		

### Order example



ME0950

Type

413

B<sub>i</sub> [mm]

RE

Stay variant

200

KR [mm]

2850

L<sub>k</sub> [mm]

HS

Stay arrangement

UAT series

## Plastic stay RD – Frame stay with hinge

- Plastic profile bars with hinge for light to medium loads. Assembly without screws.
- Available customized in **16 mm grid**.
- **Outside:** swivable to both sides.
- **Inside:** release by turning by 90°.

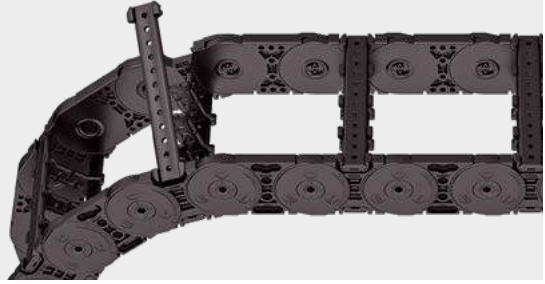



 Stay arrangement on every 2<sup>nd</sup> chain link, **standard** (HS: half-stayed)

 Stay arrangement on each chain link (**VS: fully-stayed**)

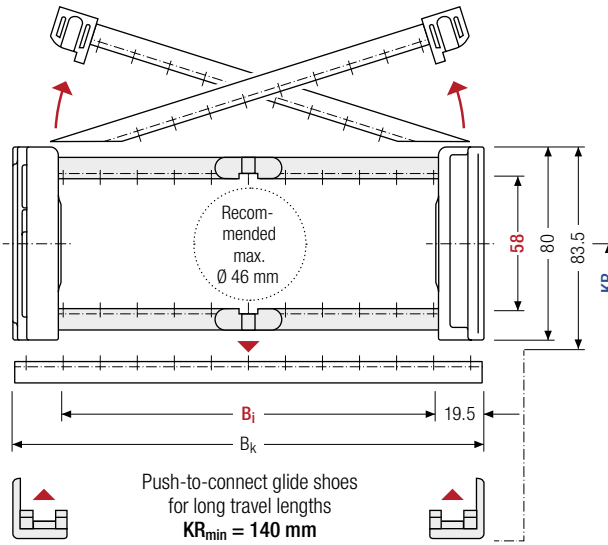
 **16 mm** B<sub>i</sub> 45 – 557 mm in **16 mm** width sections



 The maximum cable diameter strongly depends on the bending radius and the desired cable type. Please contact us.

 For rough environmental conditions, we recommend the use of OFFROAD glide shoes with 80 % higher wear volume.

### Calculating the cable carrier length

**Cable carrier length L<sub>k</sub>**

$$L_k \approx \frac{L_s}{2} + L_B$$

Cable carrier length L<sub>k</sub> rounded to pitch t

h <sub>i</sub> [mm]	h <sub>g</sub> [mm]	h <sub>g'</sub> [mm]	h <sub>g'</sub> Offroad [mm]	B <sub>i</sub> [mm]								B <sub>k</sub> [mm]	KR [mm]	q <sub>k</sub> [kg/m]		
58	80	83.5	86	45	61	77	93	109	125	141	157	173	B <sub>i</sub> + 39	140	170	3.0
				189	205	221	237	253	269	285	301	317		200	260	
				333	349	365	381	397	413	429	445	461		290	320	6.2
				477	493	509	525	541	557	380						

### Order example

 **MK0950** Type · **413** B<sub>i</sub> [mm] · **RD** Stay variant · **200** KR [mm] · **2850** L<sub>k</sub> [mm] · **HS** Stay arrangement

## Divider systems

As a standard, the divider system is mounted on each crossbar – for stay mounting on every 2<sup>nd</sup> chain link (HS).

As a standard, dividers and the complete divider system (dividers with height separations) can be moved in the cross section (**version A**).

The dividers are easily attached to the stay for applications with lateral acceleration and for applications laying on their side by simply turning the frame stay by 180°. The arresting cams click into place in the locking grids in the crossbars (**version B**).

The groove in the frame stay faces outwards.

### Divider system TS0 without height separation

Vers.	$a_T$ min [mm]	$a_x$ min [mm]	$a_c$ min [mm]	$a_x$ grid [mm]	$n_T$ min
A	5.5	14.5	8.5	–	–
B	6.5	16	10	16	–

The dividers can be moved within the cross section (version A) or fixed (version B).

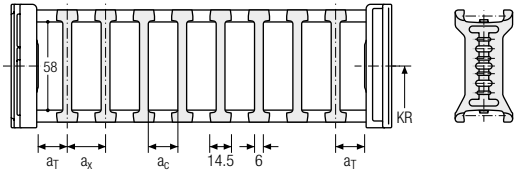

### Divider system TS1 with continuous height separation

Vers.	$a_T$ min [mm]	$a_T$ max [mm]	$a_x$ min [mm]	$a_c$ min [mm]	$a_x$ grid [mm]	$n_T$ min
A	5.5	25	14.5	8.5	–	2
B	6.5	25	16	10	16	2

The dividers can be moved within the cross section (version A) or fixed (version B).

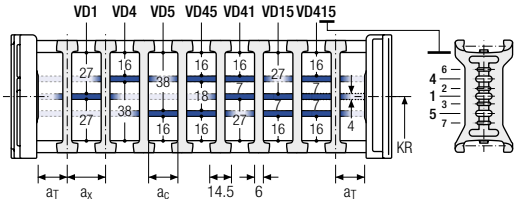

### Divider system TS2 with partial height separation

Vers.	$a_T$ min [mm]	$a_x$ min [mm]	$a_c$ min [mm]	$a_x$ grid [mm]	$n_T$ min
A	5.5	14.5/21	8.5/15	–	2
B	6.5	16/32	10/26	16	2

\* for VR0

With grid distribution (16 mm grid). The dividers are attached to the height separation, the grid can be moved in the cross section (version A) or fixed (version B).

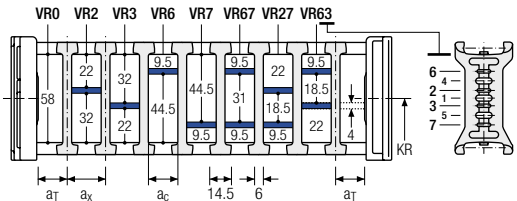

### More product information online



Assembly instructions etc.:  
Additional info via your  
smartphone or check online at  
[tsubaki-kabelschlepp.com/  
downloads](http://tsubaki-kabelschlepp.com/downloads)



Configure your custom  
cable carrier here:  
**online-engineer.de**

## Divider system TS3 with height separation made of plastic partitions

Vers.	a <sub>T</sub> min [mm]	a <sub>x</sub> min [mm]	a <sub>c</sub> min [mm]	n <sub>T</sub> min
A	4	16 / 42*	8	2

\* For aluminum partitions

The dividers are fixed by the partitions, the complete divider system is movable in the cross section.

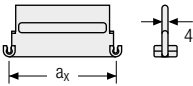
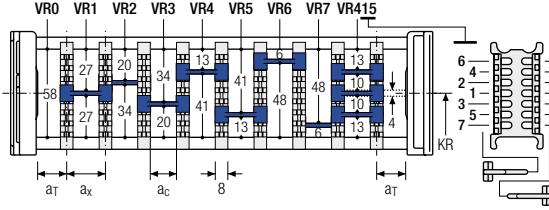

Aluminum partitions in 1 mm increments with a<sub>x</sub> > 42 mm are also available.

a <sub>x</sub> (center distance of dividers) [mm]											
a <sub>c</sub> (nominal width of inner chamber) [mm]											
16	18	23	28	32	33	38	43	48	58	64	68
8	10	15	20	24	25	30	35	40	50	56	60
78	80	88	96	112	128	144	160	176	192	208	
70	72	80	88	104	120	136	152	168	184	200	

When using plastic partitions with a<sub>x</sub> > 112 mm, we recommend an additional center support with a twin divider (S<sub>T</sub> = 4 mm). Twin dividers are also suitable for retrofitting in the partition system.

### Order example

TS3

A

3

K1

34

VR1

⋮  
 ⋮  
 ⋮

K4

38

VR3

Divider system
Version
n<sub>T</sub>
Chamber
a<sub>x</sub>
Height separation

Please state the designation of the divider system (TS0, TS1 ...), version and number of dividers per cross section [n<sub>T</sub>]. In addition, please also enter the chambers [K] from left to right, as well as the assembly distances [a<sub>T</sub>/a<sub>x</sub>] (as seen from the driver).

If using divider systems with height separation (TS1, TS3) please also state the positions [e.g. VD23] viewed from the left driver belt. You are welcome to add a sketch to your order.

### TOTALTRAX® complete systems

Benefit from the advantages of the TOTALTRAX® complete system. A complete delivery from one source – with a warranty certificate on request! Learn more at [tsubaki-kabelschlepp.com/totaltrax](https://tsubaki-kabelschlepp.com/totaltrax)

### TRAXLINE® cables for cable carriers

Hi-flex electric cables which were especially developed, optimized and tested for use in cable carriers can be found at [tsubaki-kabelschlepp.com/traxline](https://tsubaki-kabelschlepp.com/traxline)

- PROTUM® series
- K series
- UNIFLEX Advanced series
- M series
- TKHD series
- XL series
- QUANTUM® series
- TKR series
- TKA series
- UAT series

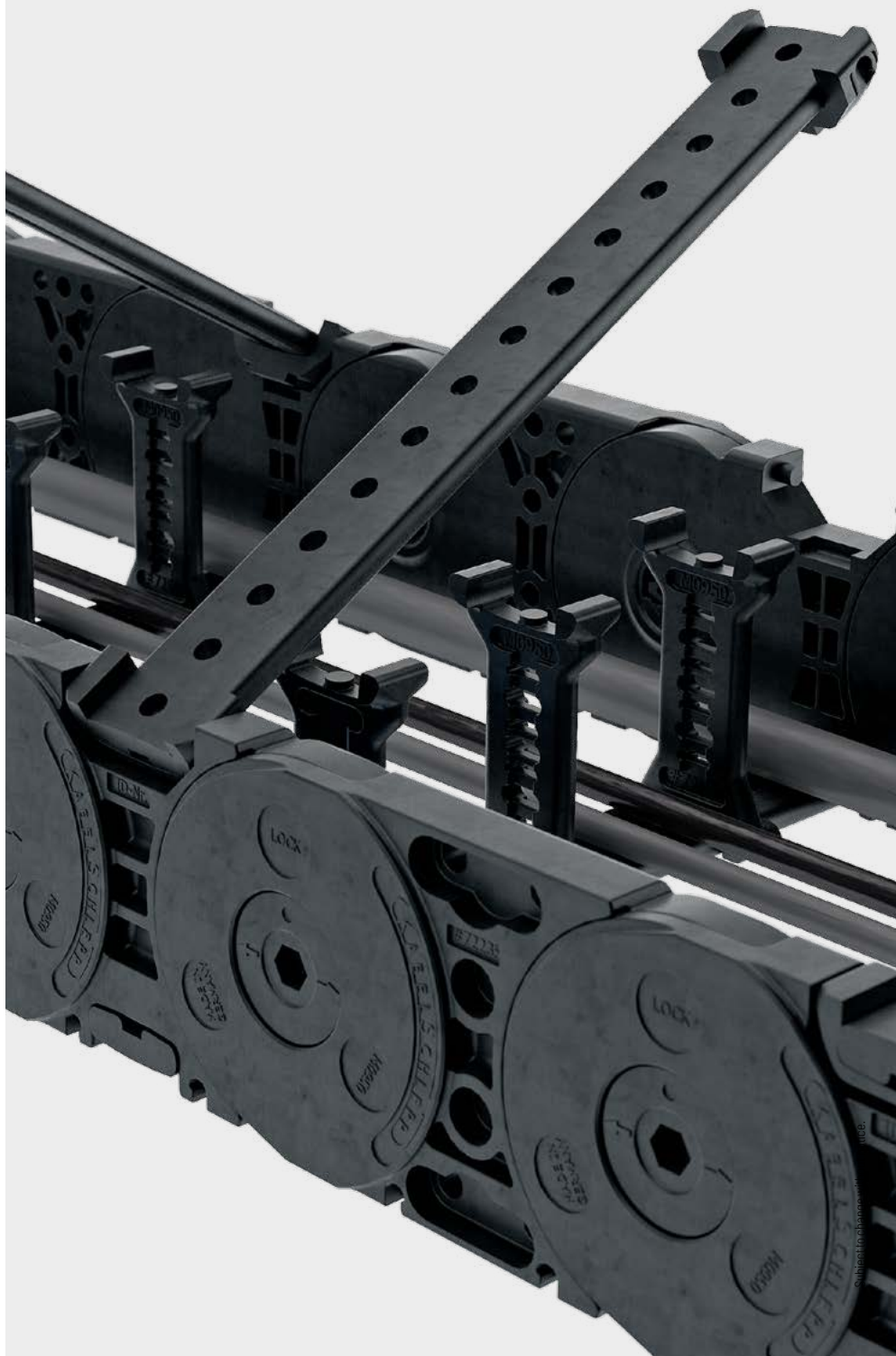
PROTUM®  
seriesK  
seriesUNIFLEX  
Advanced  
series**M**  
seriesTKHD  
seriesXL  
seriesQUANTUM®  
seriesTKR  
seriesTKA  
seriesUAT  
series

## Universal end connectors UMB – plastic (standard)

The universal mounting brackets (UMB) are made from plastic and can be mounted **from the top, from the bottom, face on or from the side.**

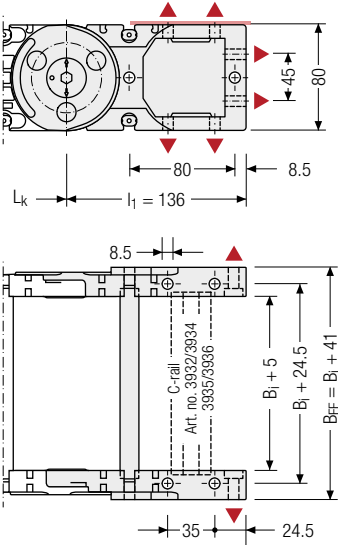

Recommended tightening torque: 27 Nm for cheese-head screws ISO 4762 - M8 - 8.8

## End connectors – plastic/steel

Plastic link end connector, steel end connector. The connection variants on the fixed point and on the driver can be combined and, if required, changed afterwards.

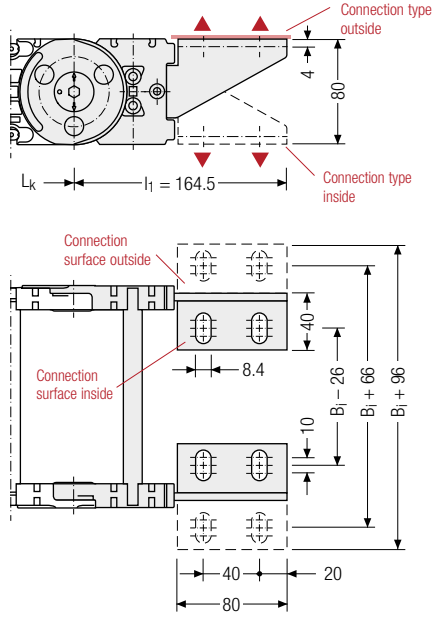

Assembly options

### Connection point

- F – fixed point
- M – driver

### Connection type

- U – universal mounting bracket

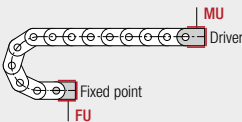

### Connection point

- F – fixed point
- M – driver

### Connection surface

- I – connection surface inside
- A – connection surface outside

### Connection type

- A – threaded joint outside (standard)
- I – threaded joint inside
- F – flange connection

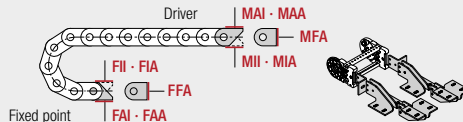

## Order example

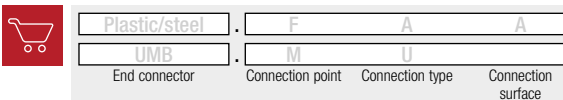

We recommend the use of strain reliefs at the driver and fixed point. See from p. 902.

PROTUM® series

K series

UNIFLEX Advanced series

M series

TKHD series

XL series

QUANTUM® series

TKR series

TKA series

UAT series



# M1250



**Pitch**  
125 mm



**Inner heights**  
66 – 76 mm



**Inner widths**  
71 – 800 mm

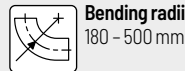

**Bending radii**  
180 – 500 mm

## Stay variants



**Aluminum stay RS** ..... page 416

### Frame stay, narrow "The standard"

- » Aluminum profile bars for light to medium loads. Assembly without screws.
- » **Outside/inside:** release by turning by 90°.



**Aluminum stay RV** ..... page 420

### Frame stay, reinforced

- » Aluminum profile bars with plastic adapter for medium to high loads and large cable carrier widths. Assembly without screws.
- » **Outside/inside:** release by turning by 90°.



**Aluminum stay RM** ..... page 424

### Frame stay, solid

- » Aluminum profile bars for heavy loads and maximum cable carrier widths. Double threaded joints on both sides "Heavy Duty".
- » **Inside/outside:** Threaded joint easy to release.



**Aluminum stay LG** ..... page 426

### Hole stay, split version

- » Optimum cable routing in the neutral bending line. Split version for easy cable routing. Stays also available unsplit.
- » **Outside/inside:** Screw-fixing easy to release.

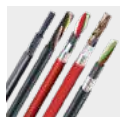

### TRAXLINE® cables for cable carriers

Hi-flex electric cables which were specially developed, optimised and tested for use in cable carriers can be found at [tsubaki-kabelschlepp.com/traxline](http://tsubaki-kabelschlepp.com/traxline).

## Stay variants

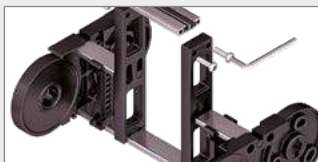

### Aluminum stay RMA ..... page 428

#### Mounting frame stay

- » Aluminum profile bars with plastic mounting frame stays for guiding very large cable diameters.
- » **Outside/inside:** Screw-fixing easy to release.



### Aluminum stay RMR ..... page 430

#### Frame rolling stay

- » Aluminum profile bars with rotating plastic rolling stay for highest requirements with gentle cable guiding. Double threaded joint on both sides.
- » **Inside/outside:** threaded joint easy to release.



### Plastic stay RE ..... page 432

#### Frame screw-in stay

- » Plastic profile bars for light to medium loads. Assembly without screws.
- » **Outside/inside:** release by turning by 90°.



### Plastic stay RD ..... page 433

#### Frame stay with hinge

- » Plastic profile bars with hinge for light to medium loads. Assembly without screws.
- » **Outside:** swivable to both sides.
- » **Inside:** release by turning by 90°.

### Serie MT

Also available as covered variants with cover system.  
More information can be found in  
chapter "MT series" from p. 610.





Unsupported arrangement

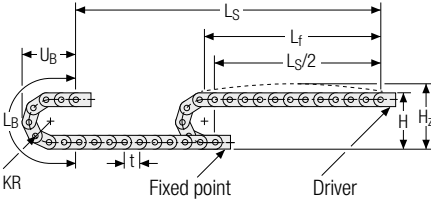

KR [mm]	H [mm]	H <sub>z</sub> [mm]	L <sub>B</sub> [mm]	U <sub>B</sub> [mm]
180	456	506	816	353
220	536	586	942	393
260	616	666	1067	433
300	696	746	1193	473
340	776	826	1319	513
380	856	906	1444	553
500	1096	1146	1821	673

Load diagram for unsupported length depending on the additional load.

Sagging of the cable carrier is technically permitted for extended travel lengths, depending on the specific application.

Intrinsic cable carrier weight  $q_k = 4.5 \text{ kg/m}$ . For other inner widths, the maximum additional load changes.

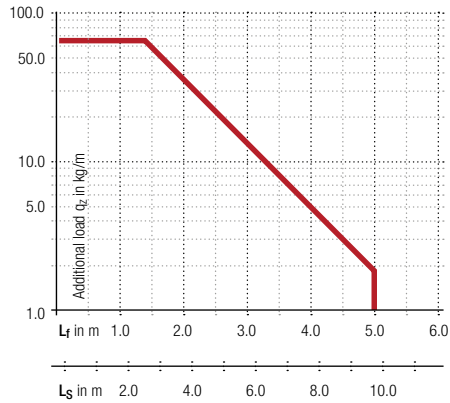

**Speed**  
up to 10 m/s

**Acceleration**  
up to 25 m/s<sup>2</sup>

**Travel length**  
up to 9.7 m

**Additional load**  
up to 65 kg/m

Gliding arrangement | GO module with chain links optimized for gliding

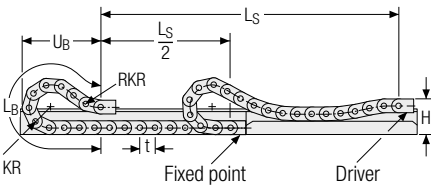

KR [mm]	H [mm]	GO module RKR [mm]	L <sub>B</sub> [mm]	U <sub>B</sub> [mm]
180	288	500	2000	930
220	288	500	2250	1015
260	288	500	2500	1095
300	288	500	2750	1177
340	288	500	3125	1318
380	288	500	3375	1403
500	288	500	4375	1770

**Speed**  
up to 8 m/s

**Acceleration**  
up to 20 m/s<sup>2</sup>

**Travel length**  
up to 320 m

**Additional load**  
up to 65 kg/m

The gliding cable carrier must be guided in a channel. See p. 842.

The GO module mounted on the driver is a defined sequence of 4 adapted KR/RKR link plates. Glide shoes have to be used for gliding applications.

PROTUM® series
K series
UNIFLEX Advanced series
M series
TKHD series
XL series
QUANTUM® series
TKR series
TKA series
UAT series

## Aluminum stay RS – frame stay narrow

- Extremely quick to open and close
- Aluminum profile bars for light to medium loads.  
Assembly without screws.
- Available customized in **1 mm grid**.
- **Outside/inside:** release by turning by 90°.



Stay arrangement on every  
2<sup>nd</sup> chain link, **standard**  
(**HS: half-stayed**)



Stay arrangement on each  
chain link (**VS: fully-stayed**)



**1 mm** B<sub>i</sub> 75 – 400 mm  
in **1 mm width sections**

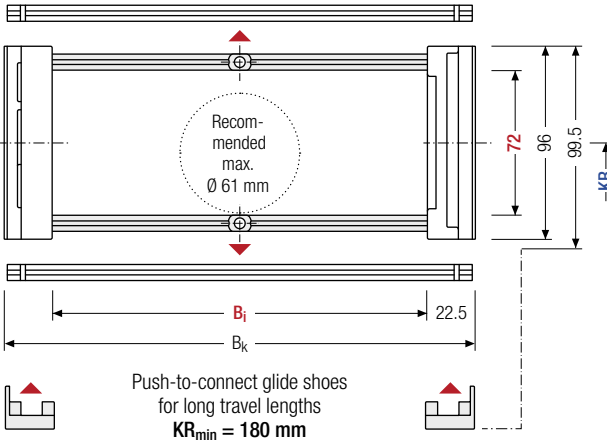

The maximum cable diameter strongly depends on the bending radius and the desired cable type. Please contact us.



For rough environmental conditions, we recommend the use of OFFROAD glide shoes with 80 % higher wear volume.

### Calculating the cable carrier length

#### Cable carrier length L<sub>k</sub>

$$L_k \approx \frac{L_s}{2} + L_B$$

Cable carrier length L<sub>k</sub>  
rounded to pitch t

h <sub>i</sub> [mm]	h <sub>G</sub> [mm]	h <sub>G'</sub> [mm]	h <sub>G'</sub> Offroad [mm]	B <sub>i</sub> [mm]*	B <sub>k</sub> [mm]	KR [mm]				q <sub>k</sub> [kg/m]			
72	96	99.5	103	75 – 400	B <sub>i</sub> + 45	180	220	260	300	340	380	500	4.10 – 4.97

\* in 1 mm width sections

### Order example



MC1250

Type

400

B<sub>i</sub> [mm]

RS

Stay variant

300

KR [mm]

4250

L<sub>k</sub> [mm]

HS

Stay arrangement

### Divider systems

As a standard, the divider system is mounted on each crossbar – for stay mounting on every 2<sup>nd</sup> chain link (HS).  
As a standard, dividers and the complete divider system (dividers with height separations) can be moved in the cross section (**version A**).

For applications with lateral acceleration and rotated by 90°, the dividers can be attached by simply clipping on a socket (available as an accessory).  
The bushing additionally serves as a spacer between the dividers and is available in 1 mm sections between 3 – 50 mm (**version B**).

### Divider system TSO without height separation

Vers.	a <sub>T</sub> min [mm]	a <sub>x</sub> min [mm]	a <sub>c</sub> min [mm]	n <sub>T</sub> min
A	7.5	15	10	2

The dividers can be moved in the cross section.

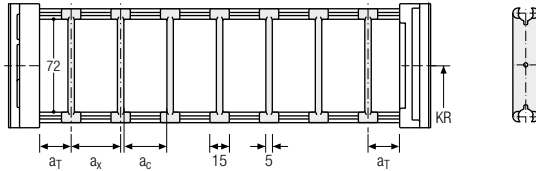

### Divider system TS1 with continuous height separation

Vers.	a <sub>T</sub> min [mm]	a <sub>T</sub> max [mm]	a <sub>x</sub> min [mm]	a <sub>c</sub> min [mm]	n <sub>T</sub> min
A	7.5	25	15	10	2

The dividers can be moved in the cross section.

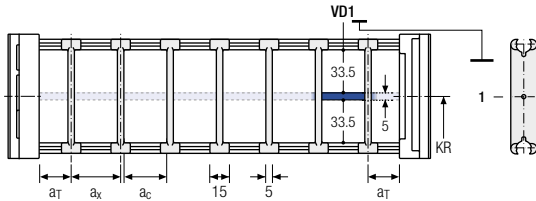

PROTUM® series
K series
UNIFLEX Advanced series
<b>M series</b>
TKHD series
XL series
QUANTUM® series
TKR series
TKA series
UAT series



**TOTALTRAX® complete systems**  
Benefit from the advantages of the TOTALTRAX® complete system. A complete delivery from one source – with a warranty certificate on request! Learn more at [tsubaki-kabelschlepp.com/totaltrax](http://tsubaki-kabelschlepp.com/totaltrax)



**TRAXLINE® cables for cable carriers**  
Hi-flex electric cables which were especially developed, optimized and tested for use in cable carriers can be found at [tsubaki-kabelschlepp.com/traxline](http://tsubaki-kabelschlepp.com/traxline)

## Divider system TS3 with height separation consisting of plastic partitions

As a standard, the divider **version A** is used for vertical partitioning within the cable carrier. The complete divider system can be moved within the cross section.

PROTUM® series

K series

UNIFLEX Advanced series

M series

TKHD series

XL series

QUANTUM® series

TKR series

TKA series

UAT series

Divider version A

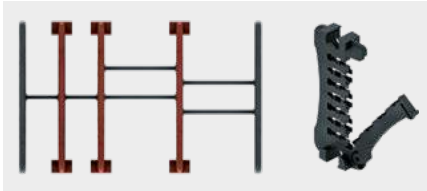

End divider

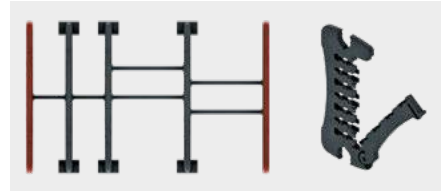

Vers.	$a_T$ min [mm]	$a_x$ min [mm]	$a_c$ min [mm]	$n_T$ min
A	6/2*	14	10	2

\* For End divider

The dividers are fixed by the partitions, the complete divider system is movable in the cross section.

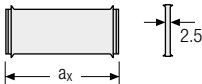
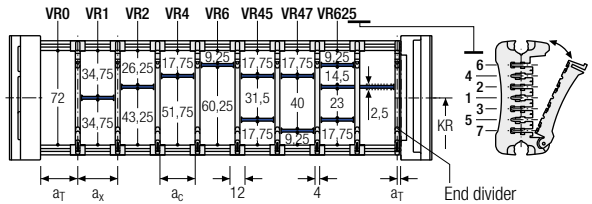

$a_x$ (center distance of dividers) [mm]																
$a_c$ (nominal width of inner chamber) [mm]																
14	16	19	23	24	28	29	32	33	34	38	39	43	44	48	49	54
10	12	15	19	20	24	25	28	29	30	34	35	39	40	44	45	50
58	59	64	68	69	74	78	79	80	84	88	89	94	96	99	112	
54	55	60	64	65	70	74	75	76	80	84	85	90	92	95	108	

When using partitions with  $a_x > 49$  mm we recommended an additional preferential central support.

### Order example

TS3 . 
 A . 
 3 . 
 K1 . 
 34 - 
 VR1  
 ⋮ ⋮ ⋮  
K4 . 
 38 - 
 VR3

Divider system
Version
 $n_T$ 
Chamber
 $a_x$ 
Height separation

Please state the designation of the divider system (TS0, TS1,...), version and number of dividers per cross section  $n_T$ . In addition, please also enter the chambers [K] from left to right, as well as the assembly distances  $[a_T/a_x]$  (as seen from the driver).

If using divider systems with height separation (TS1, TS3) please also state the positions [e.g. VD23] viewed from the left driver belt. You are welcome to add a sketch to your order.

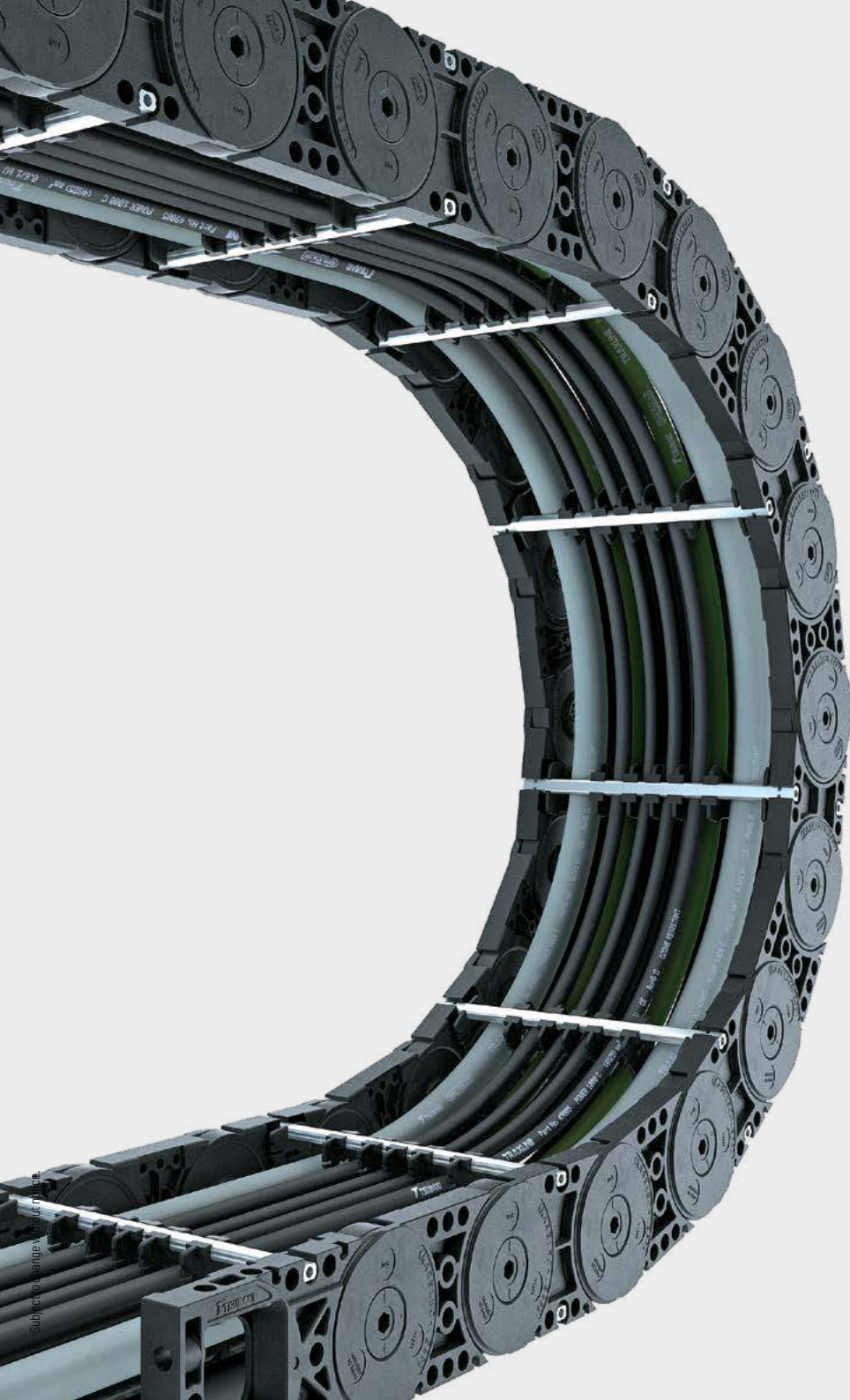

Subject to change without notice.

UAT series	TKA series	TKR series	QUANTUM® series	XL series	TKHD series	<b>M series</b>	UNIFLEX Advanced series	K series	PROTUM® series
------------	------------	------------	-----------------	-----------	-------------	-----------------	-------------------------	----------	----------------



## Aluminum stay RV – frame stay reinforced

- Aluminum profile bars with plastic adapter for medium to high loads and large cable carrier widths. Assembly without screws.
- Available customized in **1 mm grid**.
- **Outside/inside:** release by turning by 90°.



Stay arrangement on every 2<sup>nd</sup> chain link, **standard** (HS: half-stayed)



Stay arrangement on each chain link (**VS: fully-stayed**)



**1 mm** B<sub>i</sub> 100 – 600 mm in **1 mm width sections**

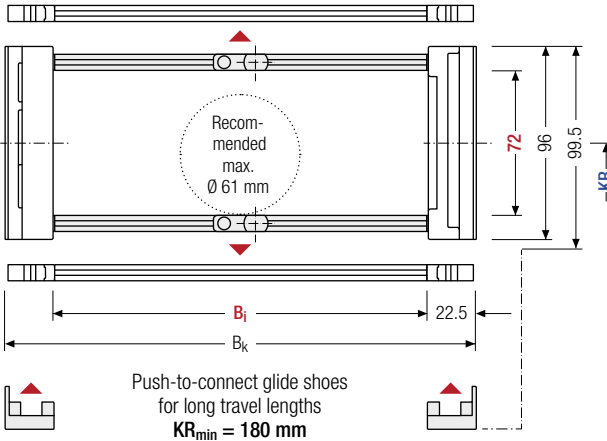

The maximum cable diameter strongly depends on the bending radius and the desired cable type. Please contact us.



For rough environmental conditions, we recommend the use of OFFROAD glide shoes with 80 % higher wear volume.

### Calculating the cable carrier length

#### Cable carrier length L<sub>k</sub>

$$L_k \approx \frac{L_s}{2} + L_B$$

Cable carrier length L<sub>k</sub> rounded to pitch t

h <sub>i</sub> [mm]	h <sub>G</sub> [mm]	h <sub>G'</sub> [mm]	h <sub>G'</sub> Offroad [mm]	B <sub>i</sub> [mm]*	B <sub>k</sub> [mm]	KR [mm]				q <sub>k</sub> [kg/m]			
72	96	99.5	103	100 – 600	B <sub>i</sub> + 45	180	220	260	300	340	380	500	4.40 – 6.18

\* in 1 mm width sections

### Order example



MC1250

Type

400

B<sub>i</sub> [mm]

RV

Stay variant

300

KR [mm]

4250

L<sub>k</sub> [mm]

HS

Stay arrangement

**Divider systems**

As a standard, the divider system is mounted on each crossbar – for stay mounting on every 2<sup>nd</sup> chain link (HS).

As a standard, dividers and the complete divider system (dividers with height separations) can be moved in the cross section (**version A**).

**Divider system TSO without height separation**

Vers.	a <sub>T</sub> min [mm]	a <sub>x</sub> min [mm]	a <sub>c</sub> min [mm]	n <sub>T</sub> min
A	8	16	10	2

The dividers can be moved in the cross section.

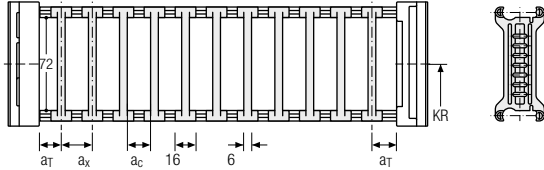

**Divider system TS1 with continuous height separation**

Vers.	a <sub>T</sub> min [mm]	a <sub>T</sub> max [mm]	a <sub>x</sub> min [mm]	a <sub>c</sub> min [mm]	n <sub>T</sub> min
A	8	25	16	10	2

The dividers can be moved in the cross section.

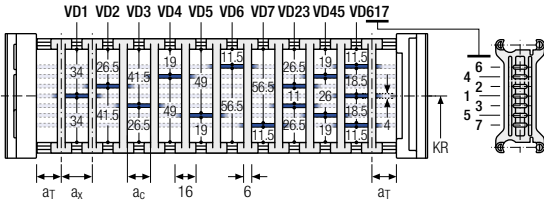

**Divider system TS2 with partial height separation**

Vers.	a <sub>T</sub> min [mm]	a <sub>x</sub> min [mm]	a <sub>c</sub> min [mm]	n <sub>T</sub> min
A	8	21	15	2

With grid distribution (1 mm grid). The dividers are attached by the height separation, the grid can be moved in the cross section.

Sliding dividers are optionally available (thickness of divider = 6 mm).

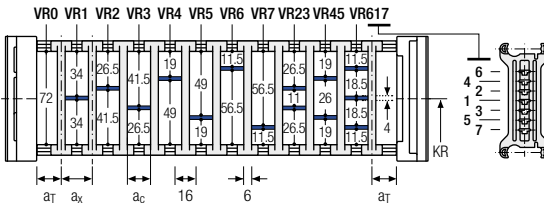

PROTUM® series
K series
UNIFLEX Advanced series
M series
TKHD series
XL series
QUANTUM® series
TKR series
TKA series
UAT series

Subject to change without notice.



**TOTALTRAX® complete systems**

Benefit from the advantages of the TOTALTRAX® complete system. A complete delivery from one source – with a warranty certificate on request! Learn more at [tsubaki-kabelschlepp.com/totaltrax](http://tsubaki-kabelschlepp.com/totaltrax)



**TRAXLINE® cables for cable carriers**

Hi-flex electric cables which were especially developed, optimized and tested for use in cable carriers can be found at [tsubaki-kabelschlepp.com/traxline](http://tsubaki-kabelschlepp.com/traxline)

## Divider system TS3 with height separation made of plastic partitions

Vers.	$a_T$ min [mm]	$a_x$ min [mm]	$a_c$ min [mm]	$n_T$ min
A	4	16/42**	8	2

\* For aluminum partitions

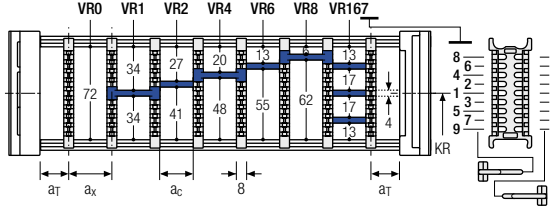

The dividers are fixed by the partitions, the complete divider system is movable in the cross section.

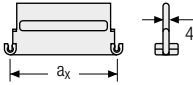

Aluminum partitions in 1 mm increments with  $a_x > 42$  mm are also available.

$a_x$ (center distance of dividers) [mm]											
$a_c$ (nominal width of inner chamber) [mm]											
16	18	23	28	32	33	38	43	48	58	64	68
8	10	15	20	24	25	30	35	40	50	56	60
78	80	88	96	112	128	144	160	176	192	208	
70	72	80	88	104	120	136	152	168	184	200	

When using **plastic partitions with  $a_x > 112$  mm**, we recommend an additional center support with a **twin divider** ( $S_T = 4$  mm). Twin dividers are also suitable for retrofitting in the partition system.

### Order example

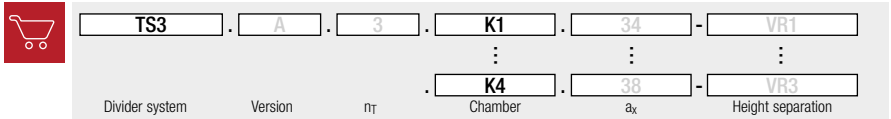

Please state the designation of the divider system (**TS0, TS1 ...**), version and number of dividers per cross section [ $n_T$ ]. In addition, please also enter the chambers [K] from left to right, as well as the assembly distances [ $a_T/a_x$ ] (as seen from the driver).

If using divider systems with height separation (**TS1, TS3**) please also state the positions [e.g. VD23] viewed from the left driver belt. You are welcome to add a sketch to your order.

### More product information online



Assembly instructions etc.:  
Additional info via your  
smartphone or check online at  
[tsubaki-kabelschlepp.com/  
support](http://tsubaki-kabelschlepp.com/support)



Configure your custom  
cable carrier here:  
**online-engineer.de**



Subject to change without notice.

UAT  
series

TKA  
series

TKR  
series

QUANTUM®  
series

XL  
series

TKHD  
series

**M**  
series

UNIFLEX  
Advanced  
series

K  
series

PROTUM®  
series

## Aluminum stay RM – frame stay solid

- Aluminum profile bars for heavy loads and maximum cable carrier widths. Double threaded joints on both sides “Heavy Duty”.
- Available customized in **1 mm grid**.
- Inside/outside:** Threaded joint easy to release.

**HEAVY DUTY**  
TSUBAKI KABELSCHLEPP

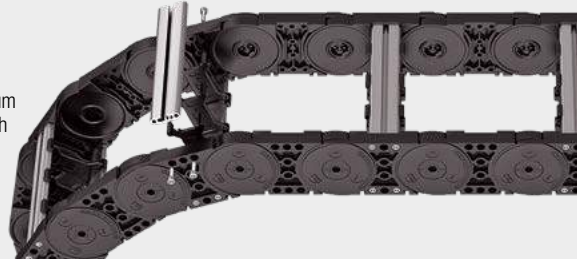

Stay arrangement on every 2<sup>nd</sup> chain link, **standard** (HS: half-stayed)



Stay arrangement on each chain link (**VS: fully-stayed**)



**1 mm** B<sub>i</sub> 100 – 800 mm in **1 mm width sections**

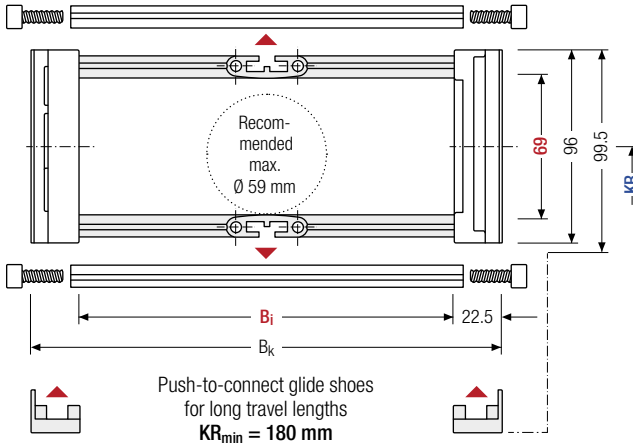

The maximum cable diameter strongly depends on the bending radius and the desired cable type. Please contact us.



For rough environmental conditions, we recommend the use of OFFROAD glide shoes with 80 % higher wear volume.

### Calculating the cable carrier length

#### Cable carrier length L<sub>k</sub>

$$L_k \approx \frac{L_s}{2} + L_B$$

Cable carrier length L<sub>k</sub> rounded to pitch t

h <sub>i</sub> [mm]	h <sub>G</sub> [mm]	h <sub>G'</sub> [mm]	h <sub>G'</sub> Offroad [mm]	B <sub>i</sub> [mm]*	B <sub>k</sub> [mm]	KR [mm]				q <sub>k</sub> [kg/m]			
69	96	99.5	103	100 – 800	B <sub>i</sub> + 45	180	220	260	300	340	380	500	4.14 – 8.48

\* in 1 mm width sections

### Order example



MC1250

Type

400

B<sub>i</sub> [mm]

RM

Stay variant

300

KR [mm]

4250

L<sub>k</sub> [mm]

HS

Stay arrangement



## Aluminum stay LG – Hole stay, split version

- Optimum cable routing in the neutral bending line.  
Split version for easy cable routing. Stays also available unsplit.
- Available customized in **1 mm width sections**.
- **Outside/inside:** Screw-fixing easy to release.



Stay arrangement on every 2<sup>nd</sup> chain link, **standard** (HS: half-stayed)



Stay arrangement on each chain link (VS: fully-stayed)



**1 mm** B<sub>i</sub> 100 – 800 mm in **1 mm width sections**

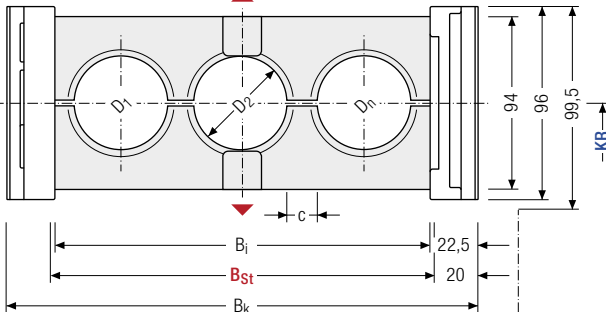
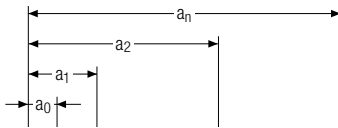

The maximum cable diameter strongly depends on the bending radius and the desired cable type. Please contact us.

### Calculating the cable carrier length

#### Cable carrier length L<sub>k</sub>

$$L_k \approx \frac{L_s}{2} + L_B$$

Cable carrier length L<sub>k</sub> rounded to pitch t

### Calculating the stay width

#### Stay width B<sub>St</sub>

$$B_{St} = \sum D + \sum c + 2 a_0$$

D <sub>max</sub> [mm]	D <sub>min</sub> [mm]	h <sub>G</sub> [mm]	B <sub>i</sub> [mm]	B <sub>St</sub> [mm]*	B <sub>k</sub> [mm]	C <sub>min</sub> [mm]	a <sub>0</sub> min [mm]	KR [mm]				q <sub>k</sub> 50 %** [kg/m]
76	12	80	100 – 800	105 – 805	B <sub>St</sub> + 40	4	12	180	220	260	300	4,75 – 11,17
								340	380	500		

\* in 1 mm width sections

\*\* Hole ratio of the hole stay approx. 50 %

### Order example



MC1250

Type

400

B<sub>i</sub> [mm]

LG

Stay variant

300

KR [mm]

4250

L<sub>k</sub> [mm]

HS

Stay arrangement

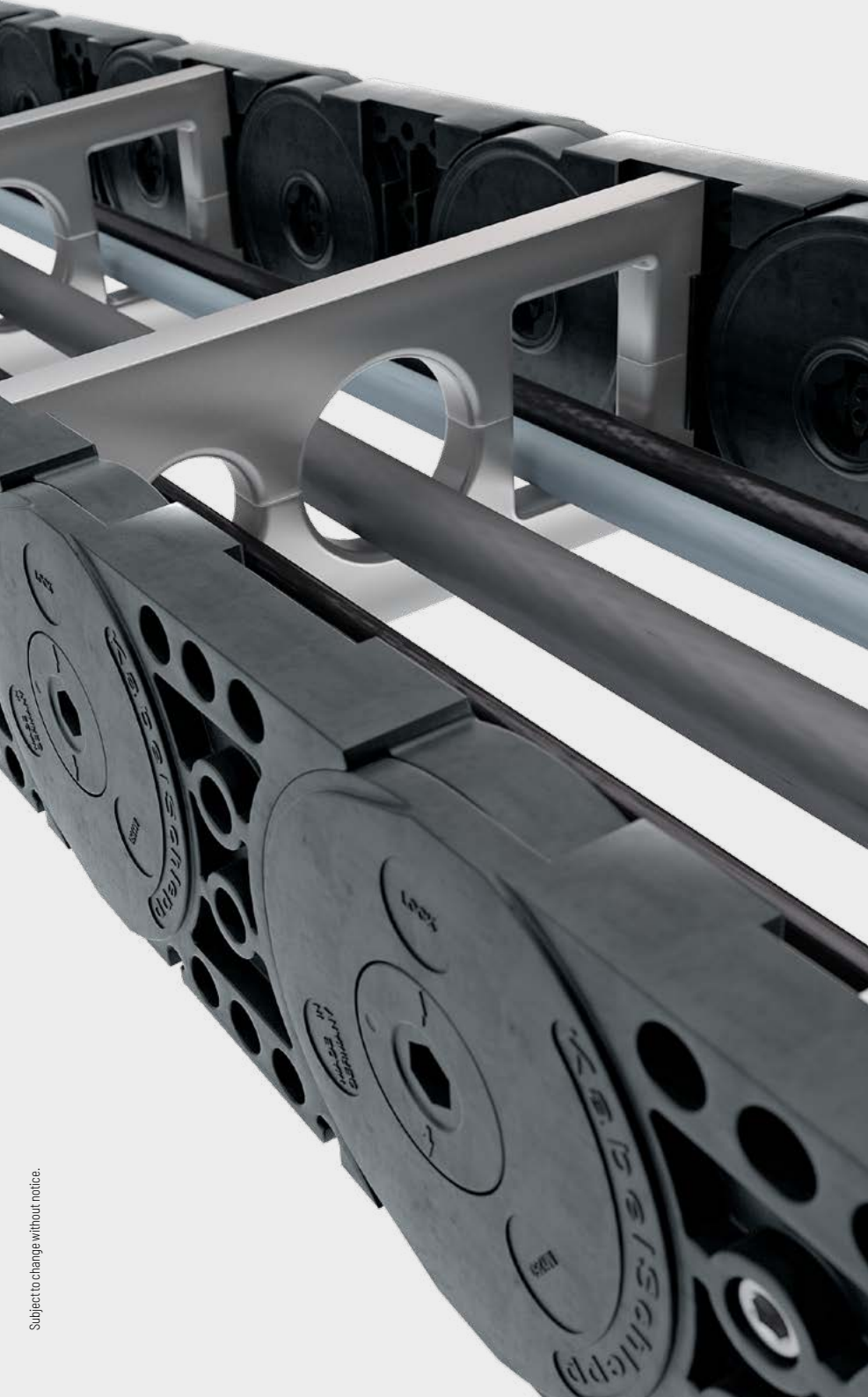

PROTUM®  
series

K  
series

UNIFLEX  
Advanced  
series

**M**  
series

TKHD  
series

XL  
series

QUANTUM®  
series

TKR  
series

TKA  
series

UAT  
series



## Aluminum stay RMA – mounting frame stay

- Aluminum profile bars with plastic mounting frame stays for guiding very large cable diameters.
- The mounting frame stay can be mounted either inside or outside in the bending radius. Available customized in **1 mm width sections**.
- **Outside/inside:** Screw-fixing easy to release.



Stay arrangement on every 2<sup>nd</sup> chain link, **standard** (HS: half-stayed)



Stay arrangement on each chain link (**VS: fully-stayed**)



**1 mm** B<sub>i</sub> 200 – 800 mm in **1 mm width sections**

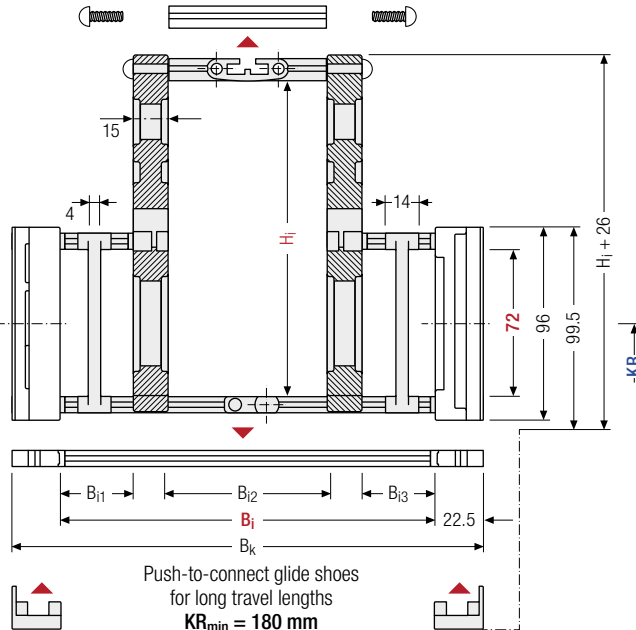

**i** The maximum cable diameter strongly depends on the bending radius and the desired cable type. Please contact us.

### Calculating the cable carrier length

#### Cable carrier length $L_k$

$$L_k \approx \frac{L_s}{2} + L_B$$

Cable carrier length  $L_k$  rounded to pitch  $t$

### **i** Intrinsic cable carrier weight

Determining the intrinsic cable carrier weight strongly depends on the selected stay arrangement. Please contact us.

$h_i$ [mm]	$H_i$ [mm]	$h_G$ [mm]	$B_i$ [mm]	$B_{i1 \text{ min}}$ [mm]	$B_{i3 \text{ min}}$ [mm]	$B_k$ [mm]	$KR$ [mm]			
72	130 160	96	200 – 800	40	40	$B_i + 45$	180	220	260	300
	200						340	380	500	

### Order example



MC1250

Type

400

$B_i$  [mm]

RMA2

Stay variant

300

$KR$  [mm]

4250

$L_k$  [mm]

HS

Stay arrangement

Assembly variants

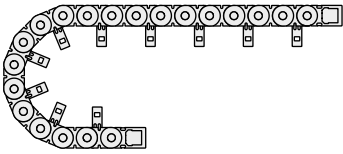

**RMA 1 – assembly to the inside:**  
 Gliding application is not possible when using assembly version RMA 1.

Observe minimum KR:  
 H<sub>i</sub> = 130 mm: KR<sub>min</sub> = 180 mm  
 H<sub>i</sub> = 160 mm: KR<sub>min</sub> = 180 mm  
 H<sub>i</sub> = 200 mm: KR<sub>min</sub> = 220 mm

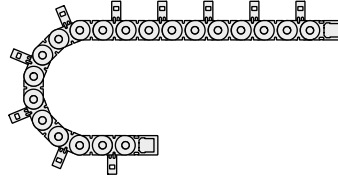

**RMA 2 – assembly to the outside:**  
 The cable carrier has to rest on the side bands and not on the stays.

Guiding in a **channel is required** for support.  
 Please contact our technical support at [technik@kabelschlepp.de](mailto:technik@kabelschlepp.de) to find the corresponding guide channel.  
 Please note the operating and installation height.



Subject to change without notice.

PROTUM® series
K series
UNIFLEX Advanced series
<b>M series</b>
TKHD series
XL series
QUANTUM® series
TKR series
TKA series
UAT series

# Aluminum stay RMR – Frame rolling stay

- Aluminum profile bars with rotating plastic rolling stay for highest requirements with gentle cable guiding. Double threaded joint on both sides.
- Available customized in **1 mm grid**.
- **Inside/outside:** Threaded joint easy to release.



Stay arrangement on every 2<sup>nd</sup> chain link, **standard** (HS: half-stayed)



Stay arrangement on each chain link (**VS: fully-stayed**)



**1 mm** B<sub>i</sub> 100 – 800 mm in **1 mm width sections**

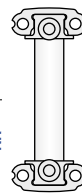
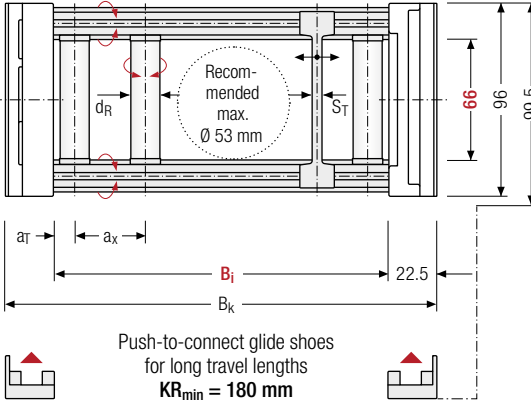

### Calculating the cable carrier length

#### Cable carrier length L<sub>k</sub>

$$L_k \approx \frac{L_s}{2} + L_B$$

Cable carrier length L<sub>k</sub> rounded to pitch t



The maximum cable diameter strongly depends on the bending radius and the desired cable type. Please contact us.



For rough environmental conditions, we recommend the use of OFFROAD glide shoes with 80 % higher wear volume.

h <sub>i</sub> [mm]	h <sub>G</sub> [mm]	h <sub>G'</sub> [mm]	h <sub>G'</sub> Offroad [mm]	B <sub>i</sub> [mm]*	B <sub>k</sub> [mm]	d <sub>R</sub> [mm]	S <sub>T</sub> [mm]	a <sub>T</sub> min [mm]	a <sub>x</sub> min [mm]	KR [mm]	q <sub>k</sub> [kg/m]
66	96	99.5	103	100 – 800	B <sub>i</sub> + 45	10	6	6.5	37	180 220 260 300 340 380 500	4.13 – 8.39

\* in 1 mm width sections

### Order example

MC1250
Type
·
400
B<sub>i</sub> [mm]
·
RMR
Stay variant
·
300
KR [mm]
·
4250
L<sub>k</sub> [mm]
·
HS
Stay arrangement



Subject to change without notice.

PROTUM®  
series

K  
series

UNIFLEX  
Advanced  
series

**M**  
series

TKHD  
series

XL  
series

QUANTUM®  
series

TKR  
series

TKA  
series

UAT  
series

## Plastic stay RE – screw-in frame stay

- Plastic profile bars for light to medium loads.  
Assembly without screws.
- Available customized in **16 mm grid**.
- **Outside/inside:** release by turning by 90°.

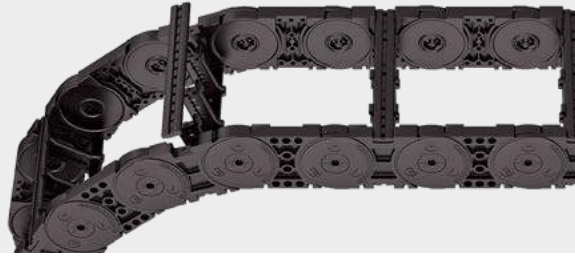

Stay arrangement on every  
2<sup>nd</sup> chain link, **standard**  
(HS: half-stayed)



Stay arrangement on each  
chain link (**VS: fully-stayed**)



**16 mm** B<sub>i</sub> 71 – 551 mm  
in **16 mm** width sections

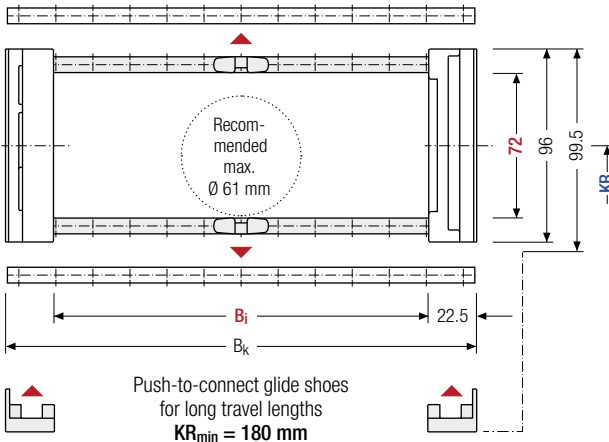

The maximum cable diameter strongly depends on the bending radius and the desired cable type. Please contact us.

For rough environmental conditions, we recommend the use of OFFROAD glide shoes with 80 % higher wear volume.

### Calculating the cable carrier length

**Cable carrier length  $L_k$**

$$L_k \approx \frac{L_s}{2} + L_B$$

Cable carrier length  $L_k$   
rounded to pitch  $t$

$h_i$ [mm]	$h_g$ [mm]	$h_g'$ [mm]	$h_g'$ Offroad [mm]	$B_i$ [mm]							$B_k$ [mm]	$KR$ [mm]	$q_k$ [kg/m]		
72	96	99.5	103	71	87	103	119	135	151	167	183	$B_i + 45$	180	220	4.30
				199	215	231	247	263	279	295	311		260	300	
				327	343	359	375	391	407	423	439		340	380	5.80
				455	471	487	503	519	535	551	500				

### Order example



**ME1250**

Type

**407**

$B_i$  [mm]

**RE**

Stay variant

**300**

$KR$  [mm]

**4250**

$L_k$  [mm]

**HS**

Stay arrangement

## Plastic stay RD – Frame stay with hinge

- Plastic profile bars with hinge for light to medium loads. Assembly without screws.
- Available customized in **16 mm grid**.
- **Outside:** swivable to both sides.
- **Inside:** release by turning by 90°.





 Stay arrangement on every 2<sup>nd</sup> chain link, **standard** (HS: half-stayed)

 Stay arrangement on each chain link (**VS: fully-stayed**)

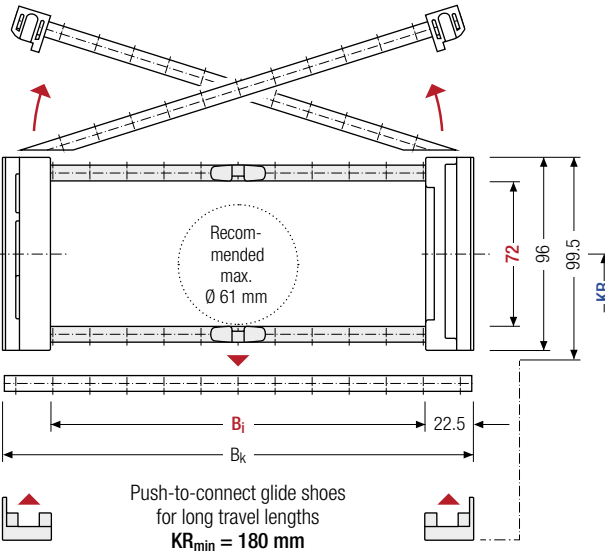
 **16 mm** B<sub>i</sub> 71 – 551 mm in 16 mm width sections



 The maximum cable diameter strongly depends on the bending radius and the desired cable type. Please contact us.

 For rough environmental conditions, we recommend the use of OFFROAD glide shoes with 80 % higher wear volume.

### Calculating the cable carrier length

#### Cable carrier length L<sub>k</sub>

$$L_k \approx \frac{L_s}{2} + L_B$$

Cable carrier length L<sub>k</sub> rounded to pitch t

h <sub>i</sub> [mm]	h <sub>G</sub> [mm]	h <sub>G'</sub> [mm]	h <sub>G</sub> : Offroad [mm]	B <sub>i</sub> [mm]								B <sub>k</sub> [mm]	KR [mm]	q <sub>k</sub> [kg/m]	
72	96	99.5	103	71	87	103	119	135	151	167	183	B <sub>i</sub> + 45	180	220	4.30
				199	215	231	247	263	279	295	311		260	300	
				327	343	359	375	391	407	423	439		340	380	5.80
				455	471	487	503	519	535	551	500				

### Order example

 **MK1250** Type · **407** B<sub>i</sub> [mm] · **RD** Stay variant · **300** KR [mm] · **4250** L<sub>k</sub> [mm] · **HS** Stay arrangement

## Divider systems

As a standard, the divider system is mounted on each crossbar – for stay mounting on every 2<sup>nd</sup> chain link (HS).

As a standard, dividers and the complete divider system (dividers with height separations) can be moved in the cross section (**version A**).

The dividers are easily attached to the stay for applications with lateral acceleration and for applications laying on their side by simply turning the frame stay by 180°. The arresting cams click into place in the locking grids in the crossbars (**version B**).

The groove in the frame stay faces outwards.

### Divider system TS0 without height separation

Vers.	$a_T$ min [mm]	$a_x$ min [mm]	$a_c$ min [mm]	$a_x$ grid [mm]	$n_T$ min
A	5	14.5	6.5	—	—
B	19.5	16	8	16	—

The dividers can be moved within the cross section (version A) or fixed (version B).

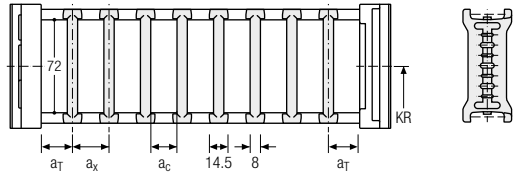

### Divider system TS1 with continuous height separation

Vers.	$a_T$ min [mm]	$a_T$ max [mm]	$a_x$ min [mm]	$a_c$ min [mm]	$a_x$ grid [mm]	$n_T$ min
A	5	25	14.5	6.5	—	2
B	19.5	19.5	16	8	16	2

The dividers can be moved within the cross section (version A) or fixed (version B).

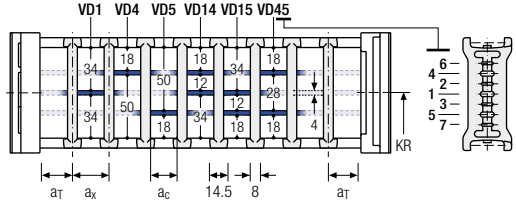

### Divider system TS2 with partial height separation

Vers.	$a_T$ min [mm]	$a_x$ min [mm]	$a_c$ min [mm]	$a_x$ grid [mm]	$n_T$ min
A	5	14.5*20	6.5*12	—	2
B	19.5	16*32	8*24	16	2

\* for VR0

With grid distribution (16 mm grid). The dividers are fixed by the height separation, the complete divider system is movable in the cross section (version A) or fixed (version B).

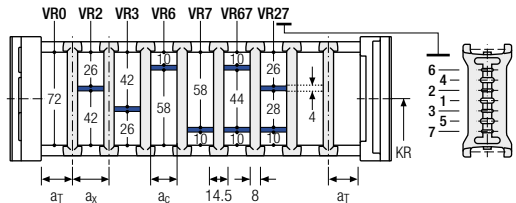

## Divider system TS3 with height separation made of plastic partitions

Vers.	a <sub>T</sub> min [mm]	a <sub>x</sub> min [mm]	a <sub>c</sub> min [mm]	n <sub>T</sub> min
A	4	16 / 42*	8	2

\* For aluminum partitions

The dividers are fixed by the partitions, the complete divider system is movable in the cross section.

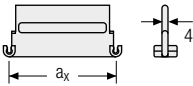
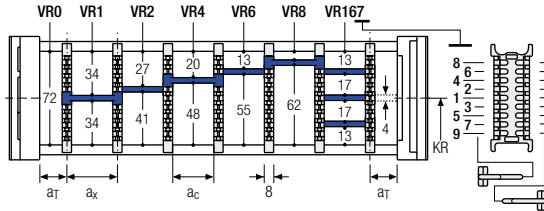

Aluminum partitions in 1 mm increments with **a<sub>x</sub> > 42 mm** are also available.

a <sub>x</sub> (center distance of dividers) [mm]											
a <sub>c</sub> (nominal width of inner chamber) [mm]											
16	18	23	28	32	33	38	43	48	58	64	68
8	10	15	20	24	25	30	35	40	50	56	60
78	80	88	96	112	128	144	160	176	192	208	
70	72	80	88	104	120	136	152	168	184	200	

When using **plastic partitions with a<sub>x</sub> > 112 mm**, we recommend an additional center support with a **twin divider** (S<sub>T</sub> = 4 mm). Twin dividers are also suitable for retrofitting in the partition system.

### Order example

TS3

A

3

K1

34

VR1

⋮  
 ⋮  
 ⋮

K4

38

VR3

Divider system    Version    n<sub>T</sub>    Chamber    a<sub>x</sub>    Height separation

Please state the designation of the divider system (**TS0, TS1 ...**), version and number of dividers per cross section [n<sub>T</sub>]. In addition, please also enter the chambers [K] from left to right, as well as the assembly distances [a<sub>T</sub>/a<sub>x</sub>] (as seen from the driver).

If using divider systems with height separation (**TS1, TS3**) please also state the positions [e.g. VD23] viewed from the left driver belt. You are welcome to add a sketch to your order.

### More product information online



Assembly instructions etc.: Additional info via your smartphone or check online at [tsubaki-kabelschlepp.com/downloads](http://tsubaki-kabelschlepp.com/downloads)



Configure your custom cable carrier: here [online-engineer.de](http://online-engineer.de)

- PROTUM® series
- K series
- UNIFLEX Advanced series
- M series
- TKHD series
- XL series
- QUANTUM® series
- TKR series
- TKA series
- UAT series



PROTUM®  
series

K  
series

UNIFLEX  
Advanced  
series

**M**  
series

TKHD  
series

XL  
series

QUANTUM®  
series

TKR  
series

TKA  
series

UAT  
series

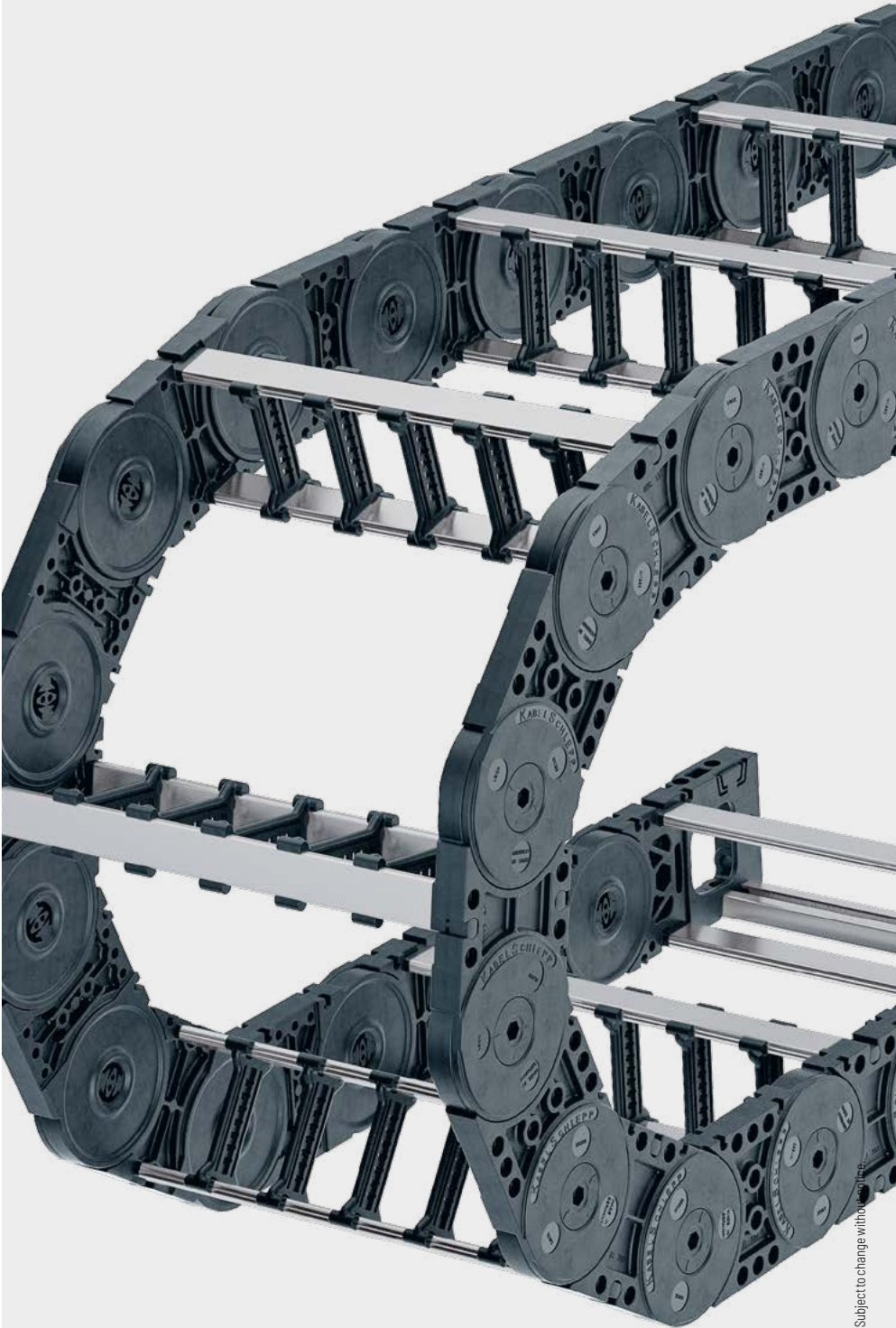

## Universal end connectors UMB – plastic (standard)

The universal mounting brackets (UMB) are made from plastic and can be mounted **from the top, from the bottom, face on or from the side.**

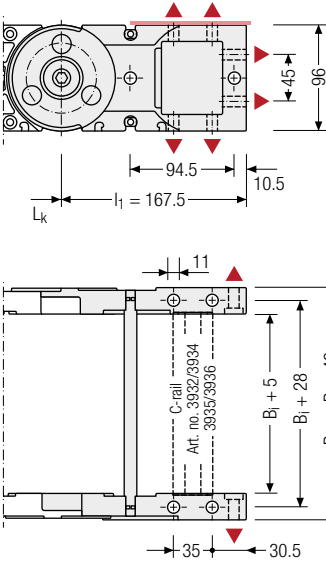

 Recommended tightening torque: 54 Nm for cheese-head screws ISO 4762 - M10 - 8.8

### Connection point

- F** – fixed point
- M** – driver

### Connection type

- U** – universal mounting bracket

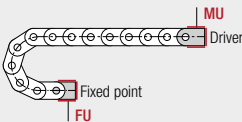

## End connectors – plastic/steel

Plastic link end connector, steel end connector. The connection variants on the fixed point and on the driver can be combined and, if required, changed afterwards.

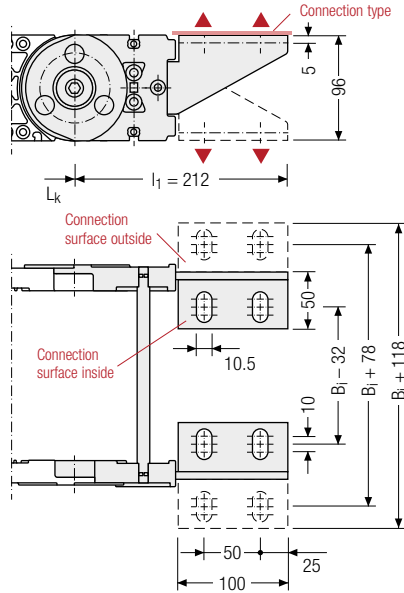

 Assembly options

### Connection point

- F** – fixed point
- M** – driver

### Connection surface

- I** – connection surface inside
- A** – connection surface outside

### Connection type

- A** – threaded joint outside (standard)
- I** – threaded joint inside
- F** – flange connection

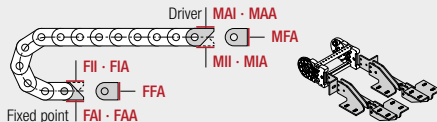

## Order example

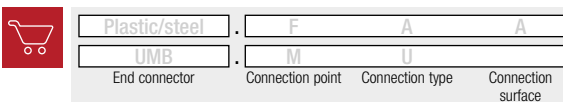

 We recommend the use of strain reliefs at the driver and fixed point. See from p. 902.

# M1300

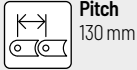

**Pitch**  
130 mm



**Inner height**  
87 - 98 mm



**Inner widths**  
100 - 800 mm



**Bending radii**  
150 - 500 mm

## Stay variants

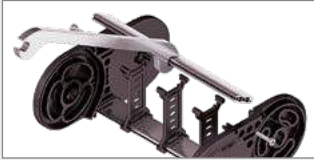

**Aluminum stay RMF** ..... page 440

### Frame stay solid with optional fixing profile

- » Aluminum profile bars for heavy loads and large cable carrier widths. Easy threaded connection.
- » **Inside/outside:** Threaded joint easy to release.

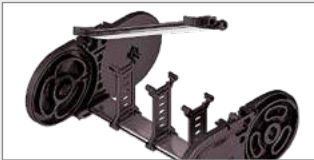

**Aluminum stay RMS** ..... page 442

### Frame stay solid with ball joint

- » Aluminum profile bars with plastic ball joint for heavy loads and large cable carrier widths. Assembly without screws.
- » **Inside/outside:** Swivable and detachable.

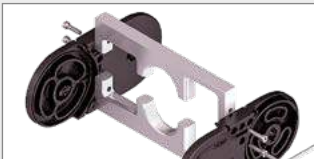

**Aluminum stay LG** ..... page 444

### Hole stay, split version

- » Optimum cable routing in the neutral bending line. Split version for easy cable routing. Stays also available unsplit.
- » **Outside/inside:** Screw-fixing easy to release.

Unsupported arrangement

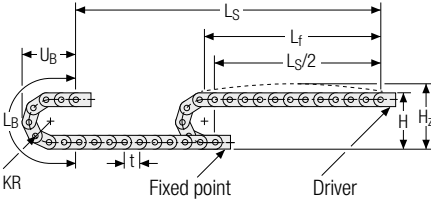

KR [mm]	H [mm]	H <sub>z</sub> [mm]	L <sub>B</sub> [mm]	U <sub>B</sub> [mm]
150	480	540	732	340
195	570	630	873	385
240	660	720	1014	430
280	740	800	1140	470
320	820	880	1266	510
360	900	960	1391	550
400	980	1040	1517	590
500	1180	1240	1831	690

Load diagram for unsupported length depending on the additional load.

Sagging of the cable carrier is technically permitted for extended travel lengths, depending on the specific application.

Intrinsic cable carrier weight  $q_k = 8.0 \text{ kg/m}$ . For other inner widths, the maximum additional load changes.

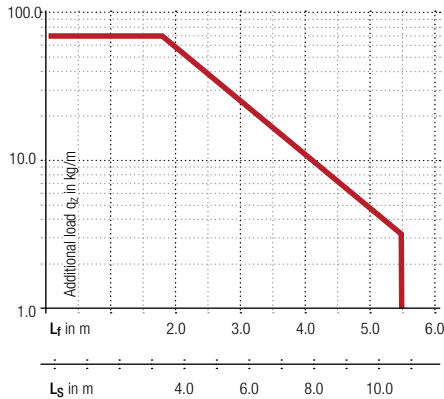

- Speed**  
up to 10 m/s
- Acceleration**  
up to 25 m/s<sup>2</sup>
- Travel length**  
up to 10.8 m
- Additional load**  
up to 70 kg/m

Gliding arrangement | GO module with chain links optimized for gliding

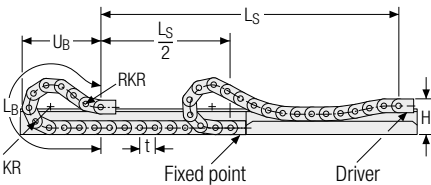

KR [mm]	H [mm]	GO module RKR [mm]	L <sub>B</sub> [mm]	U <sub>B</sub> [mm]
195	360	500	2210	1040
240	360	500	2470	1125
320	360	500	2880	1240
360	360	500	3140	1331
500	360	500	4310	1756

The cable carrier is to be used gliding only **without pre-tensioning!**

- Speed**  
up to 8 m/s
  - Acceleration**  
up to 20 m/s<sup>2</sup>
  - Travel length**  
up to 350 m
  - Additional load**  
up to 70 kg/m
- The gliding cable carrier must be guided in a channel. See p. 842.
- The GO module mounted on the driver is a defined sequence of 4 adapted KR/RKR link plates.
- Gliding shoes are required for gliding applications.

Our technical support can provide help for gliding arrangements:  
[technik@kabelschlepp.de](mailto:technik@kabelschlepp.de)

PROTUM® series
K series
UNIFLEX Advanced series
M series
TKHD series
XL series
QUANTUM® series
TKR series
TKA series
UAT series

# Aluminum stay RMF – frame stay solid with optional fixing profile

- Aluminum profile bars for heavy loads and large cable carrier widths. Easy threaded connection.
- Available customized in **1 mm grid**.
- **Inside/outside**: Threaded joint easy to release.

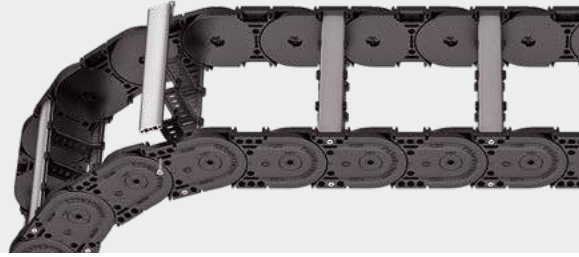

Stay arrangement on every 2<sup>nd</sup> chain link, **standard** (HS: half-stayed)



Stay arrangement on each chain link (**VS: fully-stayed**)



**1 mm** B<sub>i</sub> 100 – 800 mm in **1 mm width sections**

PROTUN® series

K series

UNIFLEX Advanced series

M series

TKHD series

XL series

QUANTUN® series

TKR series

TKA series

UAT series

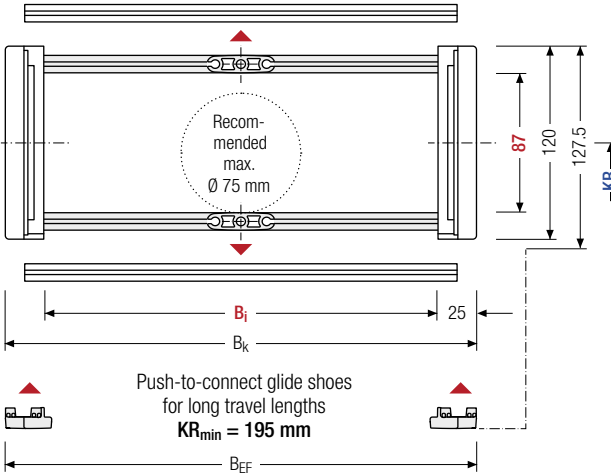

**i** The maximum cable diameter strongly depends on the bending radius and the desired cable type. Please contact us.

### Calculating the cable carrier length

**Cable carrier length L<sub>k</sub>**

$$L_k \approx \frac{L_S}{2} + L_B$$

Cable carrier length L<sub>k</sub> rounded to pitch t

h <sub>i</sub> [mm]	h <sub>G</sub> [mm]	h <sub>G'</sub> [mm]	B <sub>i</sub> [mm]*	B <sub>k</sub> [mm]	KR [mm]					q <sub>k</sub> [kg/m]			
87	120	127.5	100 – 800	B <sub>i</sub> + 50	150	195	240	280	320	360	400	500	6.24 – 9.59

\* in 1 mm width sections

### Order example

MC1300
Type
·
400
B<sub>i</sub> [mm]
·
RMF
Stay variant
·
360
KR [mm]
·
6500
L<sub>k</sub> [mm]
·
HS
Stay arrangement

Divider systems

As a standard, the divider system is mounted on each crossbar – for stay mounting on every 2<sup>nd</sup> chain link (HS). As a standard, dividers and the complete divider system (dividers with height separations) can be moved in the cross section (**version A**).

For applications with lateral acceleration and lying on the side, the dividers can be attached by simple insertion of a fixing profile into the RMF stay, available as an accessory (**version B**).

Divider system TS0 without height separation

Vers.	a <sub>T</sub> min [mm]	a <sub>x</sub> min [mm]	a <sub>c</sub> min [mm]	a <sub>x</sub> Raster [mm]	πT min
A	7.5	15	10	–	–
B	10	15	10	5	–

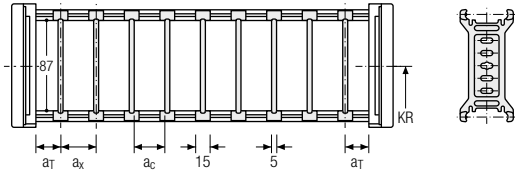

The dividers can be moved within the cross section (version A) or fixed (version B).

Divider system TS1 with continuous height separation

Vers.	a <sub>T</sub> min [mm]	a <sub>T</sub> max [mm]	a <sub>x</sub> min [mm]	a <sub>c</sub> min [mm]	a <sub>x</sub> Raster [mm]	πT min
A	7.5	25	15	10	–	2
B	10	25	15	10	5	2

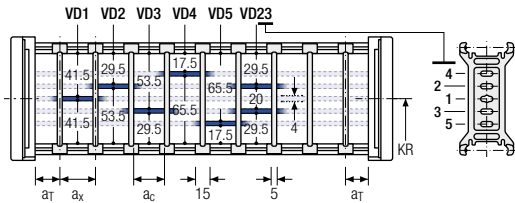

The dividers can be moved within the cross section (version A) or fixed (version B).

Divider system TS3 with partial height separation

Vers.	a <sub>T</sub> min [mm]	a <sub>x</sub> min [mm]	a <sub>c</sub> min [mm]	πT min
A	7.5	16/42*	8	2

\* For aluminum partitions

With grid distribution (1 mm grid). The dividers are attached by the height separation, the grid can be moved in the cross section.

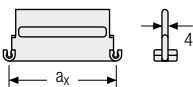
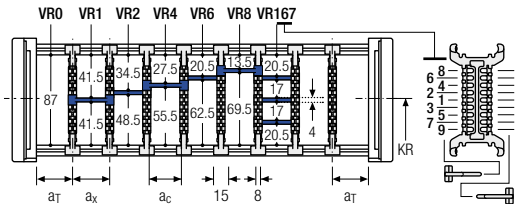

Aluminum partitions in 1 mm increments with a<sub>x</sub> > 42 mm are also available.

a <sub>x</sub> (center distance of dividers) [mm]											
a <sub>c</sub> (nominal width of inner chamber) [mm]											
16	18	23	28	32	33	38	43	48	58	64	68
8	10	15	20	24	25	30	35	40	50	56	60
78	80	88	96	112	128	144	160	176	192	208	
70	72	80	88	104	120	136	152	168	184	200	

When using plastic partitions with a<sub>x</sub> > 112 mm, we recommend an additional center support with a twin divider (S<sub>T</sub> = 5 mm). Twin dividers are also suitable for retrofitting in the partition system. The height separations VR8 and VR9 are not possible when using twin dividers.

PROTUM® series
K series
UNIFLEX Advanced series
M series
TKHD series
XL series
QUANTUM® series
TKR series
TKA series
UAT series

## Aluminum stay RMS – frame stay reinforced

- Aluminum profile bars with plastic ball joint for heavy loads and large cable carrier widths. Assembly without screws.
- Available customized in **1 mm grid**.
- **Inside/outside:** Swivable and detachable.

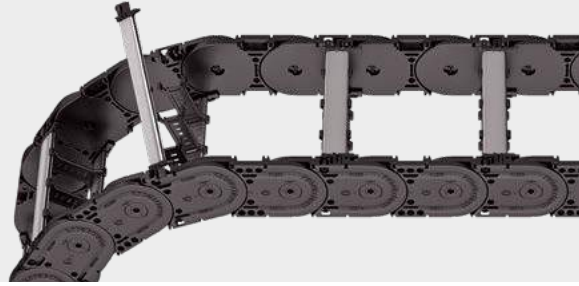

Stay arrangement on every 2<sup>nd</sup> chain link, **standard** (HS: half-stayed)



Stay arrangement on each chain link (**VS: fully-stayed**)



**1 mm** B<sub>i</sub> 100 – 800 mm in **1 mm width sections**

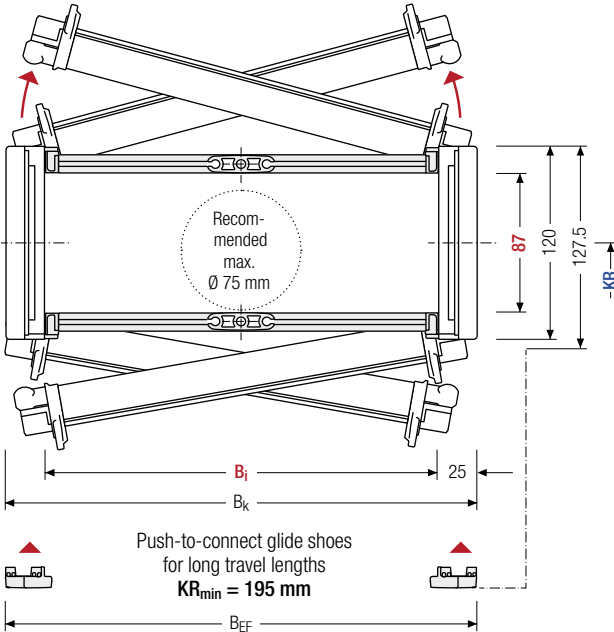

The maximum cable diameter strongly depends on the bending radius and the desired cable type. Please contact us.

### Calculating the cable carrier length

#### Cable carrier length $L_k$

$$L_k \approx \frac{L_S}{2} + L_B$$

Cable carrier length  $L_k$  rounded to pitch  $t$

$h_i$ [mm]	$h_G$ [mm]	$h_G'$ [mm]	$B_i$ [mm]*	$B_k$ [mm]	KR [mm]					$q_k$ [kg/m]			
87	120	127.5	100 – 800	$B_i + 50$	150	195	240	280	320	360	400	500	6.31 – 9.65

\* in 1 mm width sections

### Order example



MC1300

Type

400

B<sub>i</sub> [mm]

RMS

Stay variant

360

KR [mm]

6500

L<sub>k</sub> [mm]

HS

Stay arrangement

Divider systems

As a standard, the divider system is mounted on each crossbar – for stay mounting on every 2<sup>nd</sup> chain link (HS). As a standard, dividers and the complete divider system (dividers with height separations) can be moved in the cross section (**version A**).

For applications with lateral acceleration and lying on the side, the dividers can be attached by a fixing profile, available as an accessory (**version B**). The fixing profile must be installed at the factory.

Divider system TS0 without height separation

Vers.	a <sub>T</sub> min [mm]	a <sub>x</sub> min [mm]	a <sub>c</sub> min [mm]	a <sub>x</sub> Raster [mm]	π <sub>T</sub> min
A	15.5	15	10	–	–
B	18.5	15	10	5	–

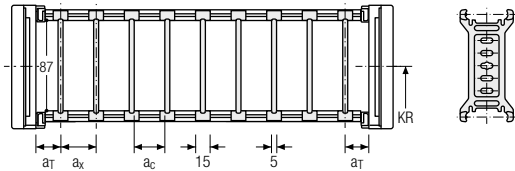

The dividers can be moved within the cross section (version A) or fixed (version B).

Divider system TS1 with continuous height separation

Vers.	a <sub>T</sub> min [mm]	a <sub>T</sub> max [mm]	a <sub>x</sub> min [mm]	a <sub>c</sub> min [mm]	a <sub>x</sub> Raster [mm]	π <sub>T</sub> min
A	15.5	25	15	10	–	2
B	18.5	25	15	10	5	2

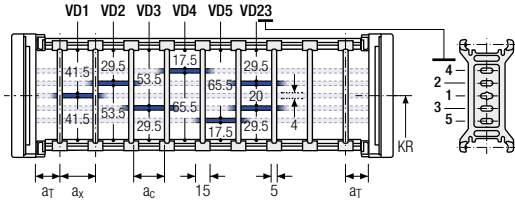

The dividers can be moved within the cross section (version A) or fixed (version B).

Divider system TS3 with partial height separation

Vers.	a <sub>T</sub> min [mm]	a <sub>x</sub> min [mm]	a <sub>c</sub> min [mm]	π <sub>T</sub> min
A	15.5	16/42*	8	2

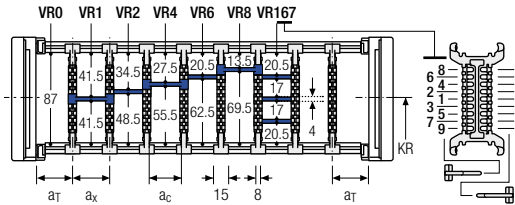

\* For aluminum partitions

With grid distribution (1 mm grid). The dividers are attached by the height separation, the grid can be moved in the cross section.

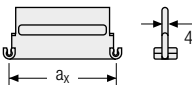

Aluminum partitions in 1 mm increments with a<sub>x</sub> > 42 mm are also available.

a <sub>x</sub> (center distance of dividers) [mm]											
a <sub>c</sub> (nominal width of inner chamber) [mm]											
16	18	23	28	32	33	38	43	48	58	64	68
8	10	15	20	24	25	30	35	40	50	56	60
78	80	88	96	112	128	144	160	176	192	208	
70	72	80	88	104	120	136	152	168	184	200	

When using plastic partitions with a<sub>x</sub> > 112 mm, we recommend an additional center support with a twin divider (S<sub>T</sub> = 5 mm). Twin dividers are also suitable for retrofitting in the partition system. The height separations VR8 and VR9 are not possible when using twin dividers.

PROTUM® series
K series
UNIFLEX Advanced series
M series
TKHD series
XL series
QUANTUM® series
TKR series
TKA series
UAT series



## Aluminum stay LG – Hole stay, split version

- Optimum cable routing in the neutral bending line.  
Split version for easy cable routing. Stays also available unsplit.
- Available customized in **1 mm width sections**.
- **Outside/inside:** Screw-fixing easy to release.

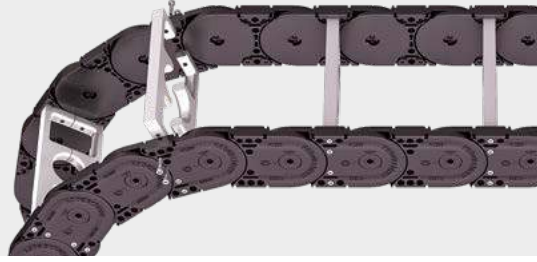

Stay arrangement on every 2<sup>nd</sup> chain link, **standard** (HS: half-stayed)



Stay arrangement on each chain link (VS: fully-stayed)



**1 mm** B<sub>i</sub> 100 – 800 mm in **1 mm width sections**

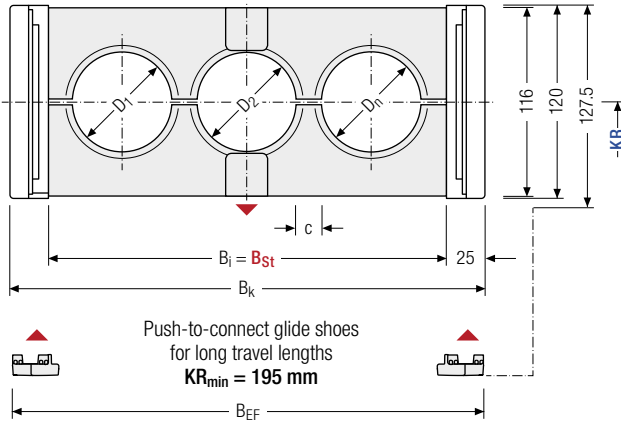
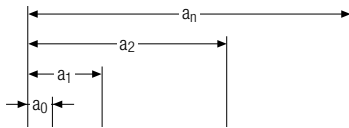

The maximum cable diameter strongly depends on the bending radius and the desired cable type. Please contact us.

### Calculating the cable carrier length

#### Cable carrier length $L_k$

$$L_k \approx \frac{L_s}{2} + L_B$$

Cable carrier length  $L_k$  rounded to pitch  $t$

### Calculating the stay width

#### Stay width $B_{St}$

$$B_{St} = \sum D + \sum c + 2 a_0$$

D <sub>max</sub> [mm]	D <sub>min</sub> [mm]	h <sub>G</sub> [mm]	B <sub>i</sub> [mm]	B <sub>St</sub> [mm]*	B <sub>k</sub> [mm]	c <sub>min</sub> [mm]	a <sub>0</sub> min [mm]	KR [mm]				q <sub>k</sub> 50 %** [kg/m]
98	12	120	100 – 800	100 – 800	B <sub>St</sub> + 50	4	13	150 320	195 360	240 400	280 500	7.04 – 13.53

\* in 1 mm width sections

\*\* Hole ratio of the hole stay approx. 50 %

### Order example



MC1300

Type

400

B<sub>i</sub> [mm]

LG

Stay variant

360

KR [mm]

6500

L<sub>k</sub> [mm]

HS

Stay arrangement

## Universal end connectors UMB – plastic (standard)

The universal mounting brackets (UMB) are made from plastic and can be mounted **from the top, from the bottom, face on or from the side.**

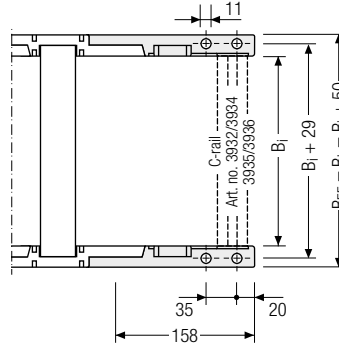
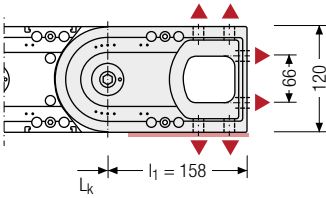

▲ Assembly options

 Recommended tightening torque: 54 Nm for cheese-head screws ISO 4762 - M10 - 8.8

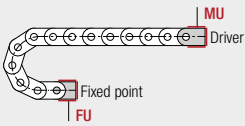

### Connection point

**F** – fixed point  
**M** – driver

### Connection type

**U** – universal mounting bracket

## Order example



UMB	F	A
UMB	M	A
End connector	Connection point	Connection type



We recommend the use of strain reliefs at the driver and fixed point. See from p. 902.

## More product information online



Assembly instructions etc.: Additional info via your smartphone or check online at [tsubaki-kabelschlepp.com/downloads](http://tsubaki-kabelschlepp.com/downloads)



Configure your custom cable carrier here: [online-engineer.de](http://online-engineer.de)