

Strain relief devices

For optimum placement
with dynamic use of cables



Trademarks are legally protected for TSUBAKI KABELSCHLEPP GmbH
as a national or international registration in the following countries:
tsubaki-kabelschlepp.com/trademarks

Strain relief devices

KABELSCHLEPP® strain reliefs were developed especially for use in cable carriers. We offer the best solution for each of many different areas of application. The type of strain

relief to be selected depends on cable type, length of the cable carrier and installation position.



LineFix® clamps page 904

- » Optimized foot geometry for secure seating in the C-profile.
- » For one cable and two or three cables stacked.
- » For C-profiles with 11 mm slot width.



Strain relief combs page 908

- » Higher fixing force than single-sided strain relief comb.
- » Uniform force transmission in push and pull direction.



SZL strain reliefs page 910

- » Gentle on the cables through large contact area with the cables.
- » Simple mounting without tools.



Block clamps page 911

- » For strain relief of hoses.

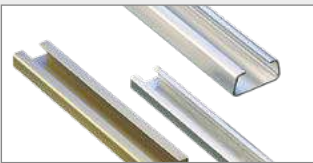

Assembly profiles page 912

- » Assembly profiles for strain relief elements

MT
seriesXLT
seriesROBOTRAX®
System

FLATVEYOR®

CLEANVEYOR®

LS/LSX
seriesS/SX
seriesS/SX-Tubes
series

Accessories

TRAXLINE®

- » For C-profiles with 11 mm slot width.
- » For one, two or three cables stacked.
- » Optimized foot geometry for secure seating in the C-profile.
- » High grade corrosion protection of the coated housing body through cathodic dip coating (CDC).
- » Pan design with support ribs for secure fixing of the cables.
- » Rounded design of the pan elements, gentle on the cables.
- » Also available in **stainless steel (ER 1S)**.

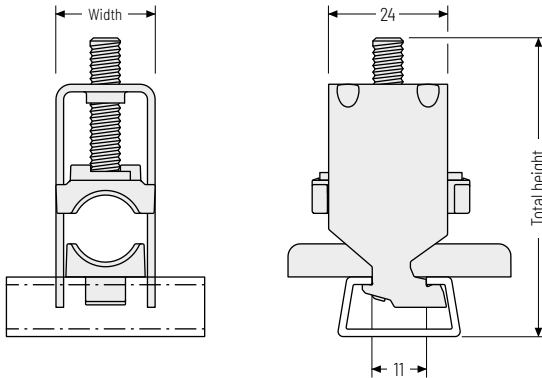

 The data for the total height are guide values.

The actual height depends on the cable diameter and the cable structure, among other things.

Pan design with optimized geometry.

The curved support ribs fix the cables very gently and reliably.



Secure seating and easy assembly

In practical operation, tensile forces occur in both cable directions. Clamps therefore have to transmit high tensile forces in the respective direction.

In contrast to standard commercial clamps, the LineFix® foot geometry ensures transmission of extremely high tensile forces equally in both directions. The catch fixes the foot securely in the C-profile when it is bolted on, preventing the crossbar from tipping out during load application, regardless of the direction of forces or installation.

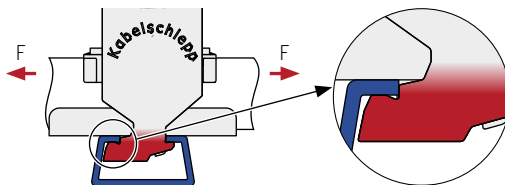

Easy installation even in tight packaging spaces through headless screw with hexagon socket.



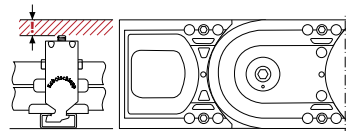

Observe minimum height

For cable carriers with upper run gliding on the lower run, the system height of the strain relief must not be higher than the chain link height!



Dimensions

Type	Designation	Material no. for one complete LineFix®	Material no. for one complete stainless steel LineFix® (ER IS)	min. cable diam. [mm]	max. cable diam. [mm]	No. of cables	Width [mm]	Total height with max. cable diam. incl. C-profile* [mm]
Single clamp								
	LF 12-1	13630	13731	6	12	1	16	55
	LF 14-1	13631	13732	12	14	1	18	52
	LF 16-1	13632	13733	14	16	1	20	54
	LF 18-1	13633	13734	16	18	1	22	56
	LF 20-1	13634	13735	18	20	1	24	59
	LF 22-1	13635	13736	20	22	1	26	61
	LF 26-1	13636	13737	22	26	1	30	70
	LF 30-1	13637	13738	26	30	1	34	74
	LF 34-1	13638	13739	30	34	1	38	78
	LF 38-1	13639	13740	34	38	1	42	82
LF 42-1	13640	13741	38	42	1	46	91	
Double clamp								
	LF 12-2	13641	13742	6	12	2	16	73
	LF 14-2	13642	13743	12	14	2	18	74
	LF 16-2	13643	13744	14	16	2	20	82
	LF 18-2	13644	13745	16	18	2	22	86
	LF 20-2	13645	13746	18	20	2	24	91
	LF 22-2	13646	13747	20	22	2	26	95
	LF 26-2	13647	13748	22	26	2	30	108
	LF 30-2	13648	13749	26	30	2	34	121
	LF 34-2	13649	13750	30	34	2	38	129
	Triple clamp							
	LF 12-3	13650	13751	6	12	3	16	98
	LF 14-3	13651	13752	12	14	3	18	98
	LF 16-3	13652	13753	14	16	3	20	105
	LF 18-3	13653	13754	16	18	3	22	111
	LF 20-3	13654	13755	18	20	3	24	118
	LF 22-3	13655	13756	20	22	3	26	130

* Item no. 3934



Additional sizes on request.



Recommended tightening torque:
max. 3 Nm for electric cables suitable for cable carriers

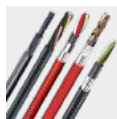

TRAXLINE® cables for cable carriers

Hi-flex electric cables which were especially developed, optimized and tested for use in cable carriers can be found at tsubaki-kabelschlepp.com/traxline

Maximum flexibility with combinable double jaws

The standard sets of LineFix® clamps in size LF/LFX 12 offer even more flexibility and mounting options due to the extension with the new double and counter jaws. Optimized for different cable diameters and individually combinable

heights, almost all requirements can be implemented without any problems.

Double jaw
LD12 d6s12



Double jaw
LD12 d6d6



Counter jaw
LG12 d6



Combination possibilities | Dimensions

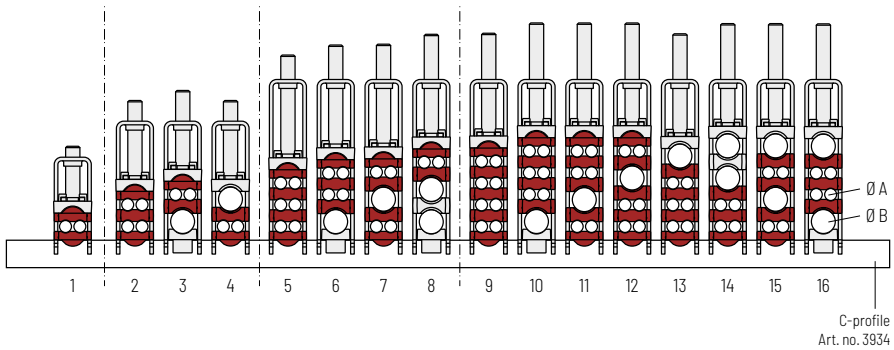

C-profile
Art. no. 3934

	Material no. for one complete LineFix®	Material no. for one complete stainless steel Line- Fix® (ER 1S)	min. cable diam. [mm]	max. cable diam. [mm]	No. of cables	Width [mm]	Total height with max. cable diam. incl. C-profile* [mm]
1	13757	13773	3-6 (2x)	-	2	16	51
2	13758	13774	3-6 (4x)	-	4	16	70
3	13759	13775	3-6 (2x)	6-12 (1x)	3	16	74
4	13760	13776	3-6 (2x)	6-12 (1x)	3	16	70
5	13761	13777	3-6 (6x)	-	6	16	89
6	13762	13778	3-6 (4x)	6-12 (1x)	5	16	94
7	13763	13779	3-6 (4x)	6-12 (1x)	5	16	94
8	13764	13780	3-6 (2x)	6-12 (2x)	4	16	98
9	13765	13781	3-6 (8x)	-	8	16	98
10	13766	13782	3-6 (6x)	6-12 (1x)	7	16	103
11	13767	13783	3-6 (6x)	6-12 (1x)	7	16	103
12	13768	13784	3-6 (6x)	6-12 (1x)	7	16	103
13	13769	13785	3-6 (6x)	6-12 (1x)	7	16	98
14	13770	13786	3-6 (4x)	6-12 (2x)	6	16	103
15	13771	13787	3-6 (4x)	6-12 (2x)	6	16	103
16	13772	13788	3-6 (4x)	6-12 (2x)	6	16	102

* Art. no. 3934

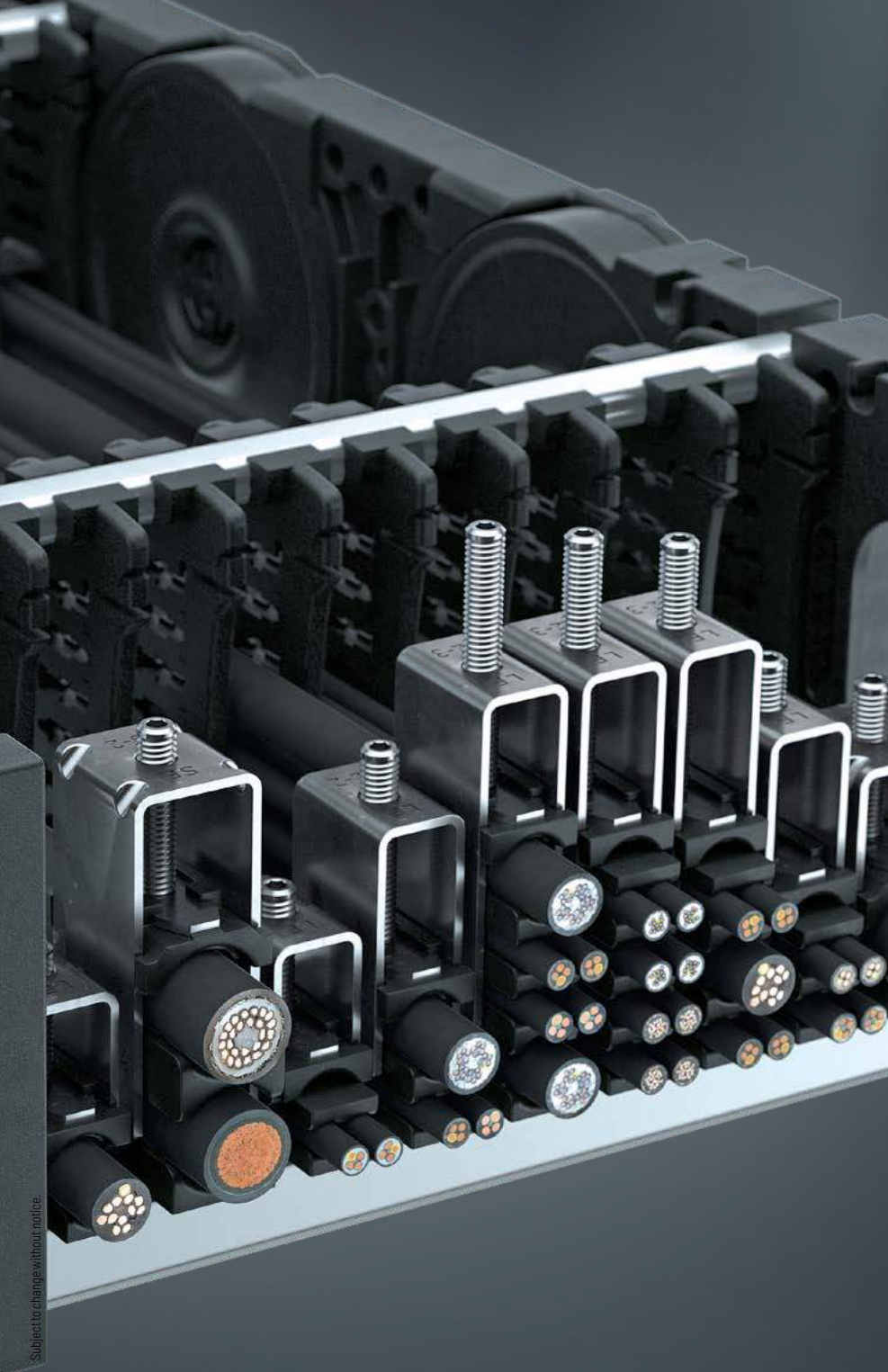

Subject to change without notice.

MT series

XLT series

ROBOTRAX® System

FLATVEYOR®

CLEANVEYOR®

LS/LSX series

S/SX series

S/SX-Tubes series

Accessories

TRAXLINE®

For separate strain relief or fastening of cables outside of the cable carrier – suitable for all cable carriers.

The strain relief combs are equipped with teeth on both sides. This allows secure fixing of each cable with two cable ties.

- » Secure fixing with two or four cable ties
- » Higher fixing force than single-sided strain relief combs
- » Uniform force transmission in push and pull direction
- » Minimized movement of cables and hoses



Strain relief comb with C-profile connections

Mat. no.	b ₁ [mm]	b ₄ [mm]	No. of teeth
53654	49	21	2 x 3
53655	74	46	2 x 5
53656	99	71	2 x 7
53657	124	96	2 x 9
53658	149	121	2 x 11
53659	174	146	2 x 13
76550	54	21	2 x 3
76551	79	46	2 x 5
76552	104	71	2 x 7
76553	129	96	2 x 9
76554	154	121	2 x 11
76555	179	146	2 x 13

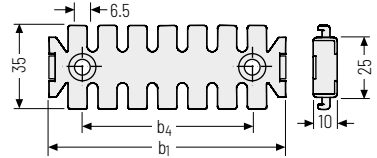

Strain relief comb

Mat. no.	b ₁ [mm]	b ₂ [mm]	b ₄ [mm]	No. of teeth
53983	43,2	53	14	2 x 3
53684	60,0	53	14	2 x 4
57350	61,0	70	20	2 x 4

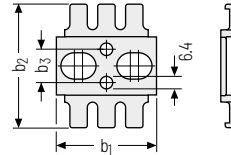

Mat. no.	b ₁ [mm]	b ₂ [mm]	b ₄ [mm]	No. of teeth
53984	63,2	53	15,2	2 x 4
53985	83,2	53	35,2	2 x 6
53986	108,2	53	60,2	2 x 8
53685	85,0	53	25,0	2 x 6
53686	110,0	53	50,0	2 x 8
53687	135,0	53	75,0	2 x 10
53688	160,0	53	100,0	2 x 12
57351	86,0	70	20,0	2 x 6
57352	111,0	70	40,0	2 x 8
57354	136,0	70	65,0	2 x 10
57355	161,0	70	90,0	2 x 12
57356	186,0	70	115,0	2 x 14
57357	211,0	70	140,0	2 x 16
57358	236,0	70	165,0	2 x 18
57359	261,0	70	190,0	2 x 20

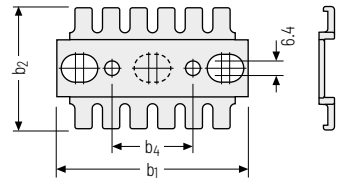

Variable strain relief comb for C-profiles

The variable strain relief combs can be combined with each other as desired in the 1-fold and 5-fold versions and clipped into the C-profiles #3931, #3934, #3935 and 3936 (see page 912).

Mat. no.	b ₁ [mm]	b ₂ [mm]	No. of teeth
3950	12,5	48	2 x 1
3951	62,5	48	2 x 5

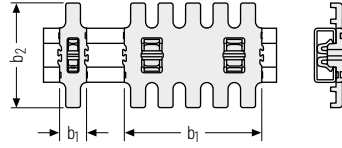

MT series

XLT series

ROBOTRAX® System

FLATVEVOR®

CLEANVEVOR®

LS/LSX series

S/SX series

S/SX-Tubes series

Accessories

TRAXLINE®

- » Cost-effective
- » Assembly - easy, fast and without tools
- » Large-area surrounding of the cables
- » Low height
- » Without screws and cable ties
- » Contact force defined by spring tension bracket
- » Suitable for standard commercial profile rails
- » Protected against vibrations
- » Long service life for dynamic applications
- » Also usable as strain relief in control cabinets

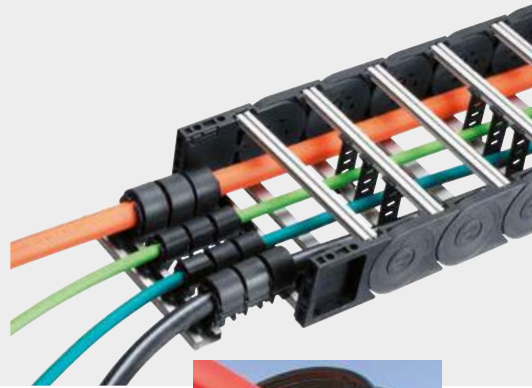
MT
seriesXL
seriesROBOTRAX®
System

FLATVEYOR®

CLEANVEYOR®

LS/LSX
seriesS/SX
seriesS/SX-Tubes
series

Accessories

TRAXLINE®

Available sizes

Type	Mat. no.	for cable Ø [mm]	Width Bat		Height H [mm]
			Ø min [mm]	Ø max [mm]	
SZL 8	24989	> 5.0 - 8.0	16	16	28
SZL 10	24990	> 8.0 - 10.5	20	20	30
SZL 14	24991	> 10.5 - 14.5	23	26	35
SZL 18	24992	> 14.5 - 18.0	25	32	40
SZL 22	24993	> 18.0 - 22.0	30	36	44
SZL 27	24994	> 22.0 - 27.0	34	39	50
SZL 32	24995	> 27.0 - 32.0	39	44	56

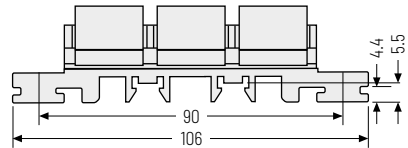
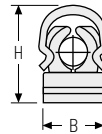

Fixing options



1. Clipped into a C-profile



2. Clipped onto a DIN rail



3. Inserted into two C-profiles



4. Directly bolted on

Installation of the SZL strain relief



Block clamps | Overview

- » For strain relief of hoses
- » With clamping screw(s) and support rail nut
- » Hoses and cables
- » For C-rails with slot widths of 11 mm and 16 mm



Available sizes

Type	Mat. no.	for diameter [mm]	Width B [mm]	Height H [mm]
BS 0.06	16701	6-7	28	27
BS 0.07	16702	7-8	28	27
BS 0.08	16703	8-9	28	27
BS 0.09	16704	9-10	28	27
BS 0.10	16705	10-12	28	27
BS 1.06	16706	6-7	37	27
BS 1.07	16707	7-8	37	27
BS 1.08	16708	8-9	37	27
BS 1.09	16709	9-10	37	27
BS 1.10	16710	10-11	37	27
BS 1.12	16711	12-14	37	27
BS 2.14	16712	14-16	42	33
BS 2.16	16713	16-18	42	33
BS 2.18	16714	18-20	42	33
BS 3.20	16715	20-22	50	36
BS 3.22	16716	22-23	50	36
BS 3.23	16717	23-25	50	36
BS 3.25	16718	25-27	50	36
BS 3.27	16719	27-30	59	42
BS 3.30	16721	30-34	59	42
BS 4.32	16722	32-34	59	42
BS 4.34	16723	34-36	71	56
BS 4.35	16724	35-37	71	56
BS 4.38	16725	38-40	71	56
BS 4.40	16726	40-42	71	56
BS 4.42	16727	42-44	71	56
BS 5.45	16728	45-48	86	66
BS 5.48	16729	48-51	86	66
BS 5.51	16731	51-54	86	66

Type BS 0

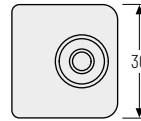
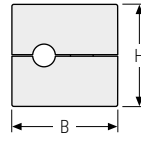
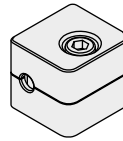

Type BS 1 - BS 5

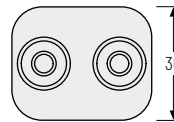
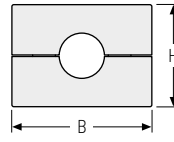
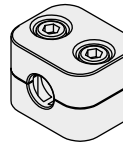

 Suitable for **C profiles** with **11 mm** slot (Article no. 3931, 3934, 3935, 3936) as well as for **C-profiles** with **16 mm** slot (Article no. 3932, 3938, 3939)

- » Assembly profiles for strain relief elements – for all commercially available clamps
- » Length in 1 mm grid available



MT series

XLT series

ROBOTRAX® System

FLATVEYOR®

CLEANVEYOR®

LS/SX series

S/SX series

S/SX-Tubes series

Accessories

TRAXLINE®

C-profile 25 x 10 mm

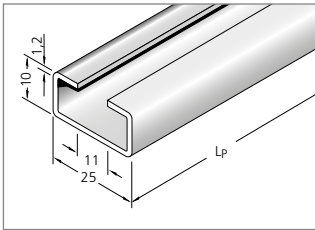

Suitable for all LineFix® clamps

(slot width 11 mm),

LineFix® types see page 904.

Material **Article no.**

Galvanized steel 3931

Attach profile with cheese-head screws M6 – DIN 6912

C-profile 25 x 12 mm

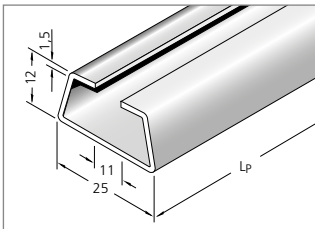

Suitable for all LineFix® clamps

(slot width 11 mm),

LineFix® types see page 904.

Material **Article no.**

Galvanized steel 3934

Attach profile with cheese-head screws M6 – DIN 6912

C-profile 34 x 15 mm

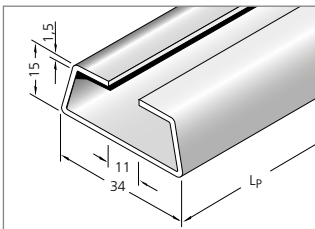

Suitable for all LineFix® clamps

(slot width 11 mm),

LineFix® types see page 904.

Material **Article no.**

Galvanized steel 3935

Stainless steel (ER 1S) 3936

Attach profile with cheese-head screws M6 – DIN 6912

C-profile 34 x 15 mm

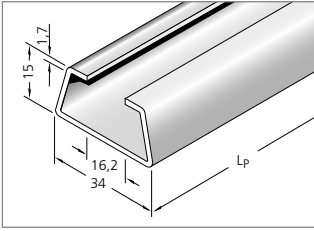

Suitable for all standard clamps
(slot width 16 - 17 mm),

Material

Steel

Article no.

3932

Attach profile with cheese-head screws M10 - DIN 6912

 The selection of the suitable C-profile depends on the connecting element.

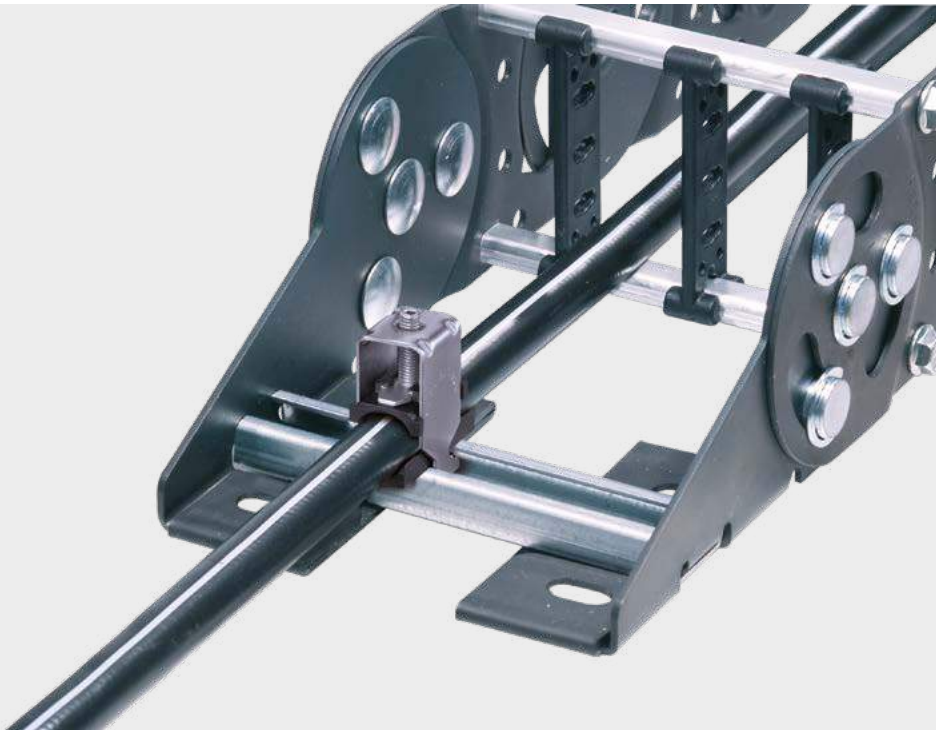

Subject to change without notice.

MT series

XLT series

ROBOTRAX® System

FLATVEYOR®

CLEANVEYOR®

LS/LSX series

S/SX series

S/SX-Tubes series

Accessories

TRAXLINE®