

EGB series

EGB40S

齿形带滑块式/皮带驱动



基本规格

伺服马达功率 (W)	200W / 400W / 750W	
重复定位精度 (mm)	±0.05	
皮带宽度	25	
导程(mm)	100	
最高速度(mm/s)	5000	
额定出力(N)	34 / 68 / 127	
最大可搬质量(Kg)	水平	44
	端面	32
标准有效行程(mm)	100~4000 (50 间距)	

型号构成



电机安装方向

请根据马达安装位置选择驱动轴方向，配合右侧选型

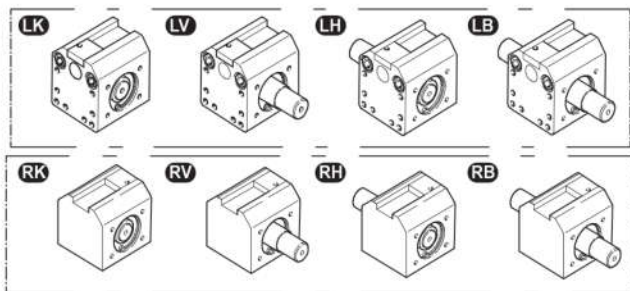

安装支架

ST40-01、ST40-02(底部使用)
ST40-03(端部使用)

▶ P.E-32

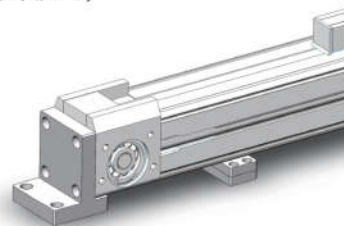

〈参考〉容许悬臂长度

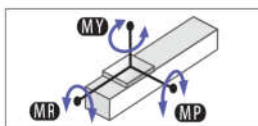
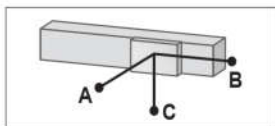
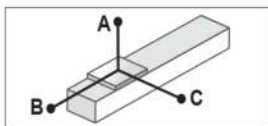

水平使用时

(单位:mm)

墙面安装使用时

(单位:mm)

(单位:N.m)

导程	负载 (Kg)	A	B	C
100	10	1200	2200	500
	30	350	500	160

导程	负载 (Kg)	A	B	C
100	10	520	2100	1100
	30	170	520	365

MR	MP	MY
120	330	330

尺寸图

■ EGB40S-LB-RK-D

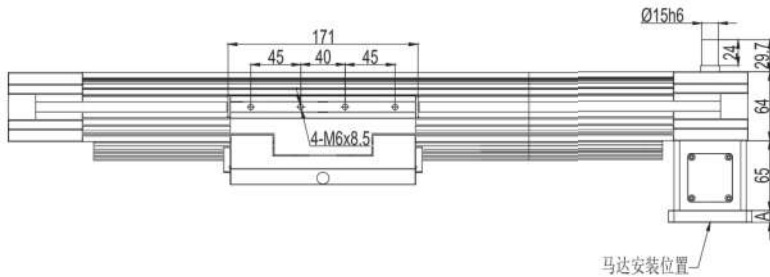
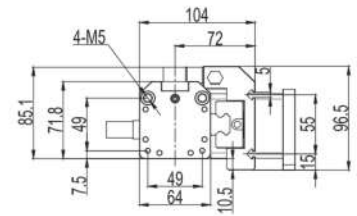
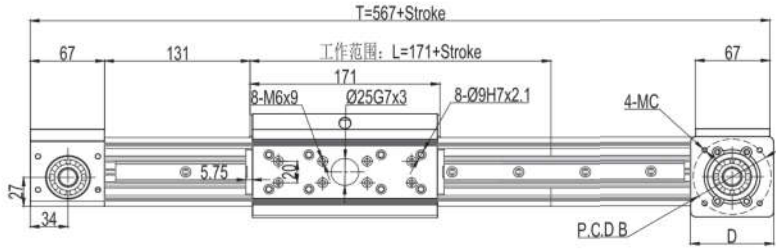

	A	B	C	D
400W	11	70	M4/M5	75
750W	21	90	M5/M6	80

行程	50	200	400	600	800	1000	1200	1400	1600	1800	2000	2200	2400	2600	2800	3000	3200	3400
L	221	371	571	771	971	1171	1371	1571	1771	1971	2171	2371	2571	2771	2971	3171	3371	3571
T	617	767	967	1167	1367	1567	1767	1967	2167	2367	2567	2767	2967	3167	3367	3567	3767	3967

■ EGB40S-LB-RK-P

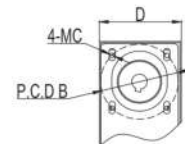
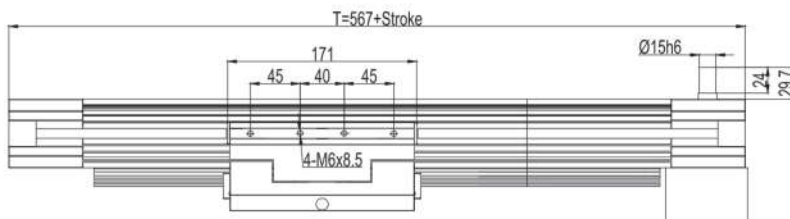
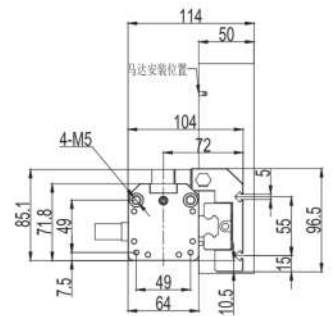
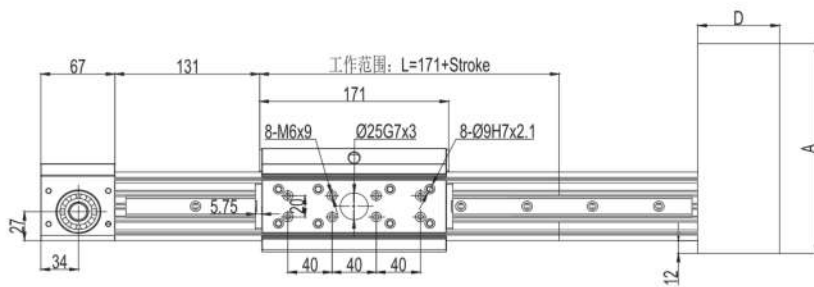

	A	B	C	D
400W	198	70	M4/M5	74
750W	209	90	M5/M6	84

行程	50	200	400	600	800	1000	1200	1400	1600	1800	2000	2200	2400	2600	2800	3000	3200	3400
L	221	371	571	771	971	1171	1371	1571	1771	1971	2171	2371	2571	2771	2971	3171	3371	3571
T	617	767	967	1167	1367	1567	1767	1967	2167	2367	2567	2767	2967	3167	3367	3567	3767	3967

齿形带滑块式/皮带驱动/EGB40S

■ EGB40S-LH-RK-D

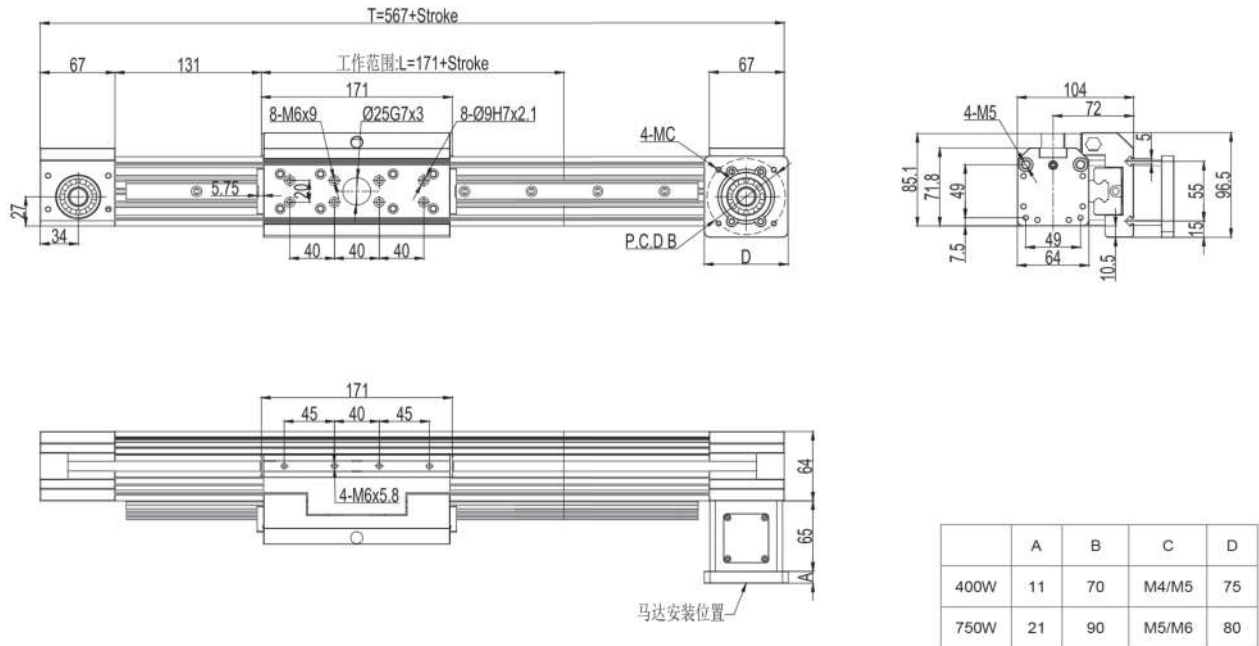

行程	50	200	400	600	800	1000	1200	1400	1600	1800	2000	2200	2400	2600	2800	3000	3200	3400
L	221	371	571	771	971	1171	1371	1571	1771	1971	2171	2371	2571	2771	2971	3171	3371	3571
T	617	767	967	1167	1367	1567	1767	1967	2167	2367	2567	2767	2967	3167	3367	3567	3767	3967

■ EGB40S-LH-RK-P

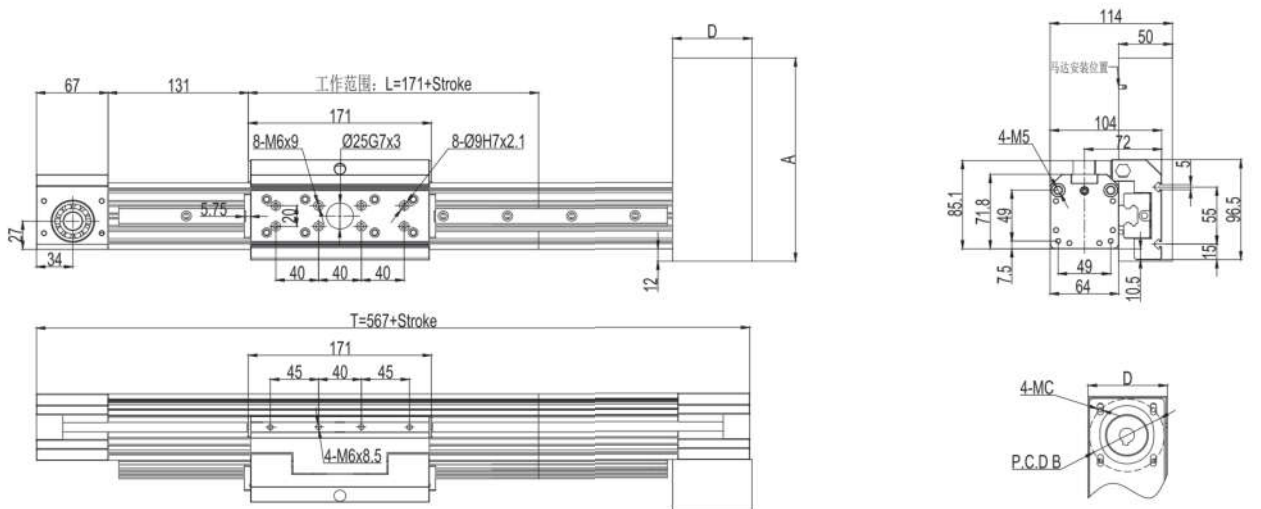

行程	50	200	400	600	800	1000	1200	1400	1600	1800	2000	2200	2400	2600	2800	3000	3200	3400
L	221	371	571	771	971	1171	1371	1571	1771	1971	2171	2371	2571	2771	2971	3171	3371	3571
T	617	767	967	1167	1367	1567	1767	1967	2167	2367	2567	2767	2967	3167	3367	3567	3767	3967

■ EGB40S-LK-RB-D

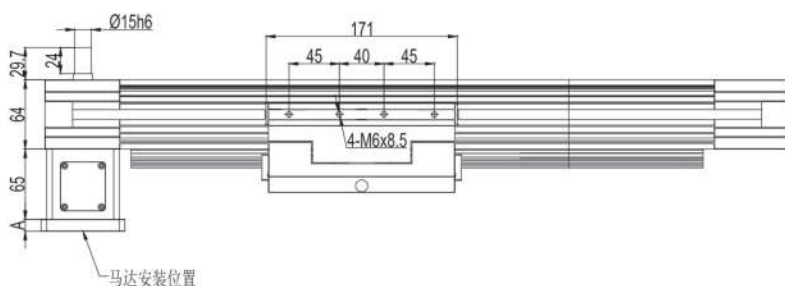
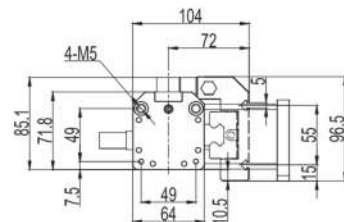
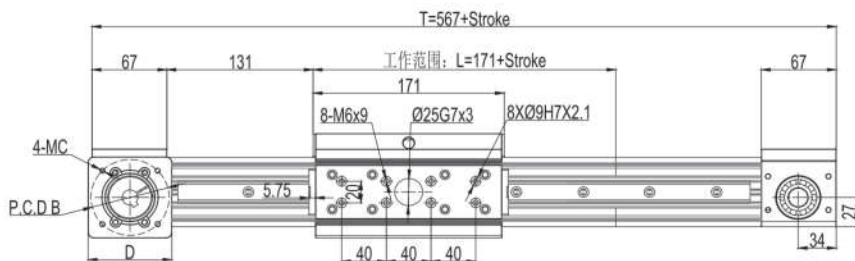

	A	B	C	D
400W	11	70	M4/M5	75
750W	21	90	M5/M6	80

行程	50	200	400	600	800	1000	1200	1400	1600	1800	2000	2200	2400	2600	2800	3000	3200	3400
L	221	371	571	771	971	1171	1371	1571	1771	1971	2171	2371	2571	2771	2971	3171	3371	3571
T	617	767	967	1167	1367	1567	1767	1967	2167	2367	2567	2767	2967	3167	3367	3567	3767	3967

■ EGB40S-LK-RB-P

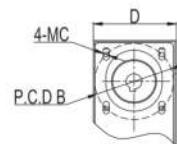
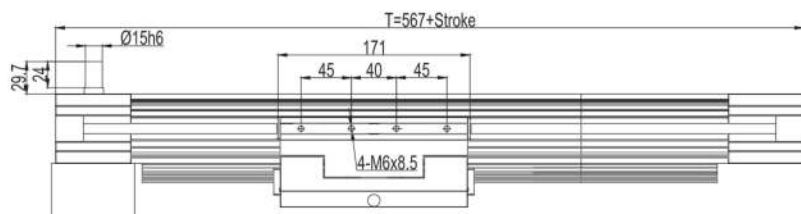
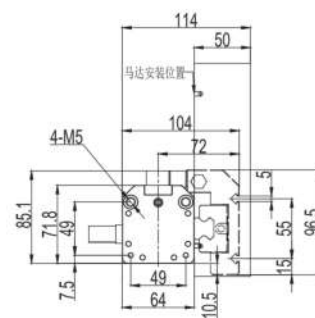
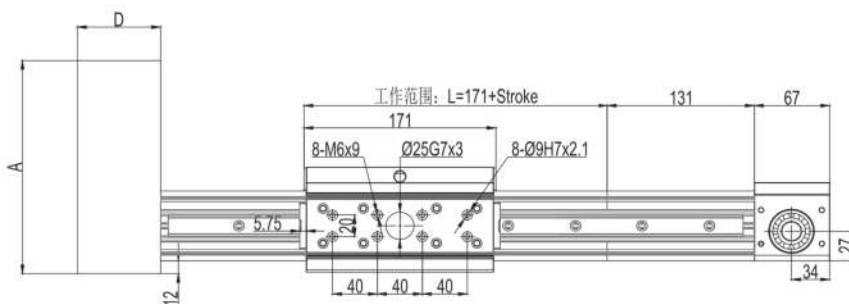

	A	B	C	D
400W	198	70	M4/M5	74
750W	209	90	M5/M6	84

行程	50	200	400	600	800	1000	1200	1400	1600	1800	2000	2200	2400	2600	2800	3000	3200	3400
L	221	371	571	771	971	1171	1371	1571	1771	1971	2171	2371	2571	2771	2971	3171	3371	3571
T	617	767	967	1167	1367	1567	1767	1967	2167	2367	2567	2767	2967	3167	3367	3567	3767	3967

半封密螺杆
全封密螺杆
半封密皮带
全封密皮带
齿形带滑块
齿形带滑块
电动推杆
驱动一体式
直线引动器
减速机

齿形带滑块式/皮带驱动/EGB40S

■ EGB40S-LK-RH-D

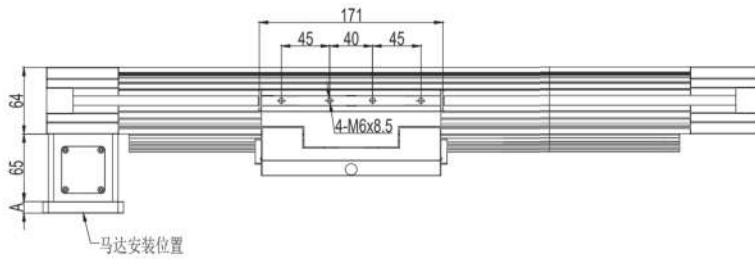
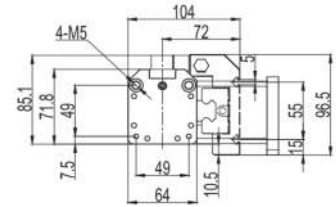
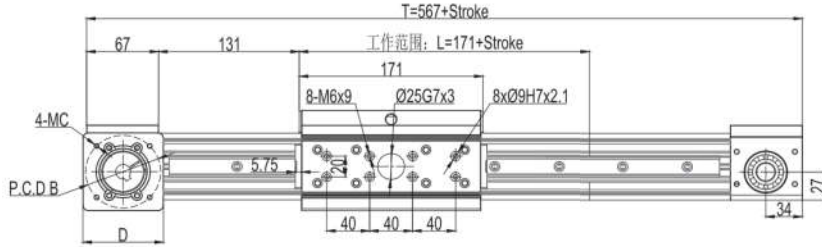

	A	B	C	D
400W	11	70	M4/M5	75
750W	21	90	M5/M6	80

行程	50	200	400	600	800	1000	1200	1400	1600	1800	2000	2200	2400	2600	2800	3000	3200	3400
L	221	371	571	771	971	1171	1371	1571	1771	1971	2171	2371	2571	2771	2971	3171	3371	3571
T	617	767	967	1167	1367	1567	1767	1967	2167	2367	2567	2767	2967	3167	3367	3567	3767	3967

■ EGB40S-LK-RH-P

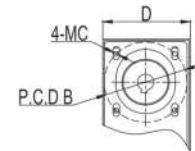
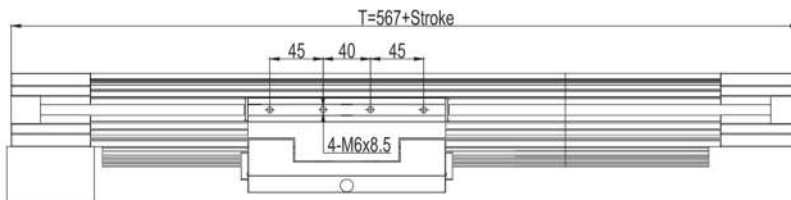
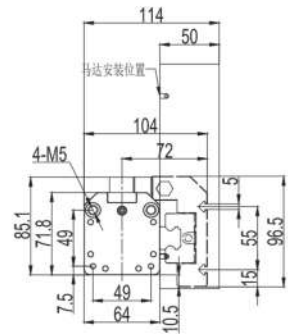
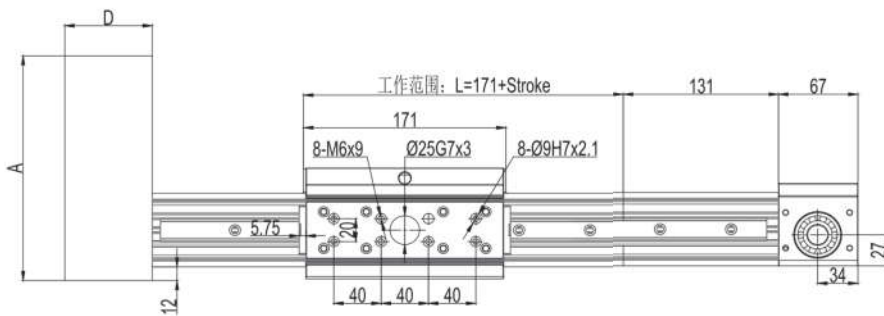

	A	B	C	D
400W	198	70	M4/M5	74
750W	209	90	M5/M6	84

行程	50	200	400	600	800	1000	1200	1400	1600	1800	2000	2200	2400	2600	2800	3000	3200	3400
L	221	371	571	771	971	1171	1371	1571	1771	1971	2171	2371	2571	2771	2971	3171	3371	3571
T	617	767	967	1167	1367	1567	1767	1967	2167	2367	2567	2767	2967	3167	3367	3567	3767	3967

■ EGB40S-LK-RV-D

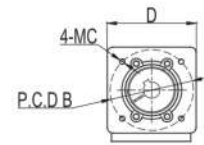
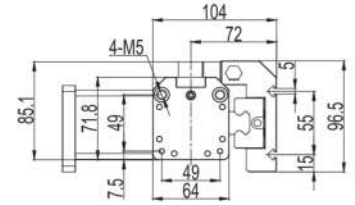
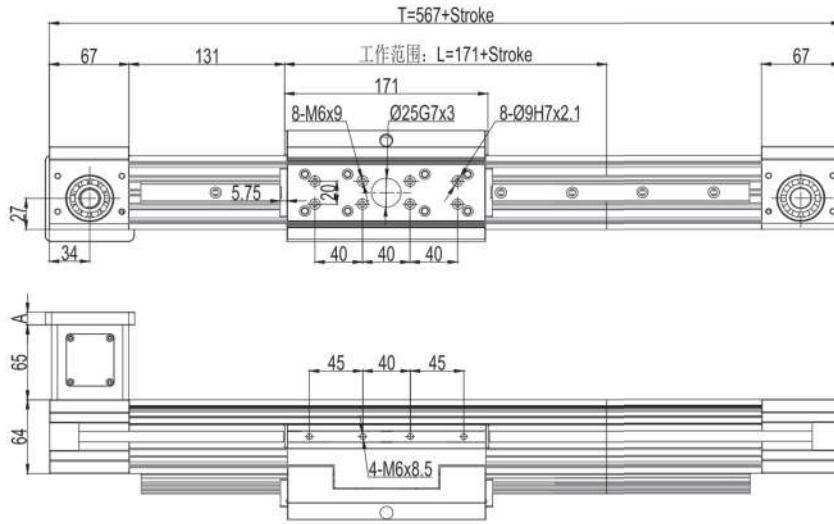

	A	B	C	D
400W	11	70	M4/M5	75
750W	21	90	M5/M6	80

行程	50	200	400	600	800	1000	1200	1400	1600	1800	2000	2200	2400	2600	2800	3000	3200	3400
L	221	371	571	771	971	1171	1371	1571	1771	1971	2171	2371	2571	2771	2971	3171	3371	3571
T	617	767	967	1167	1367	1567	1767	1967	2167	2367	2567	2767	2967	3167	3367	3567	3767	3967

■ EGB40S-LK-RV-P

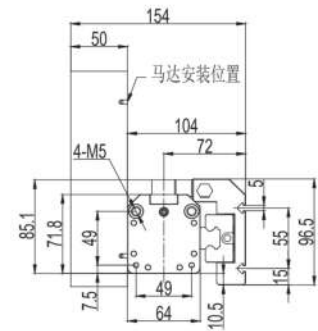
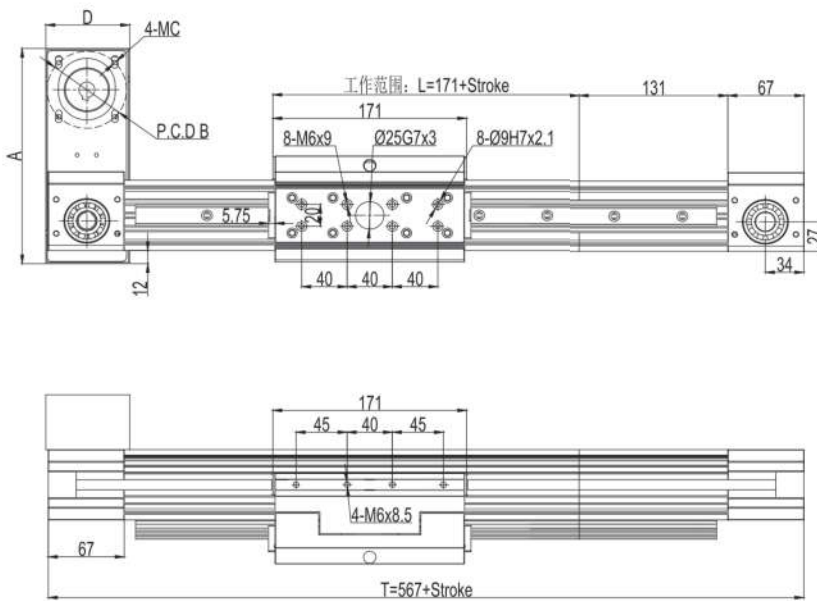

	A	B	C	D
400W	198	70	M4/M5	74
750W	209	90	M5/M6	84

行程	50	200	400	600	800	1000	1200	1400	1600	1800	2000	2200	2400	2600	2800	3000	3200	3400
L	221	371	571	771	971	1171	1371	1571	1771	1971	2171	2371	2571	2771	2971	3171	3371	3571
T	617	767	967	1167	1367	1567	1767	1967	2167	2367	2567	2767	2967	3167	3367	3567	3767	3967

齿形带滑块式/皮带驱动/EGB40S

■ EGB40S-LV-RK-D

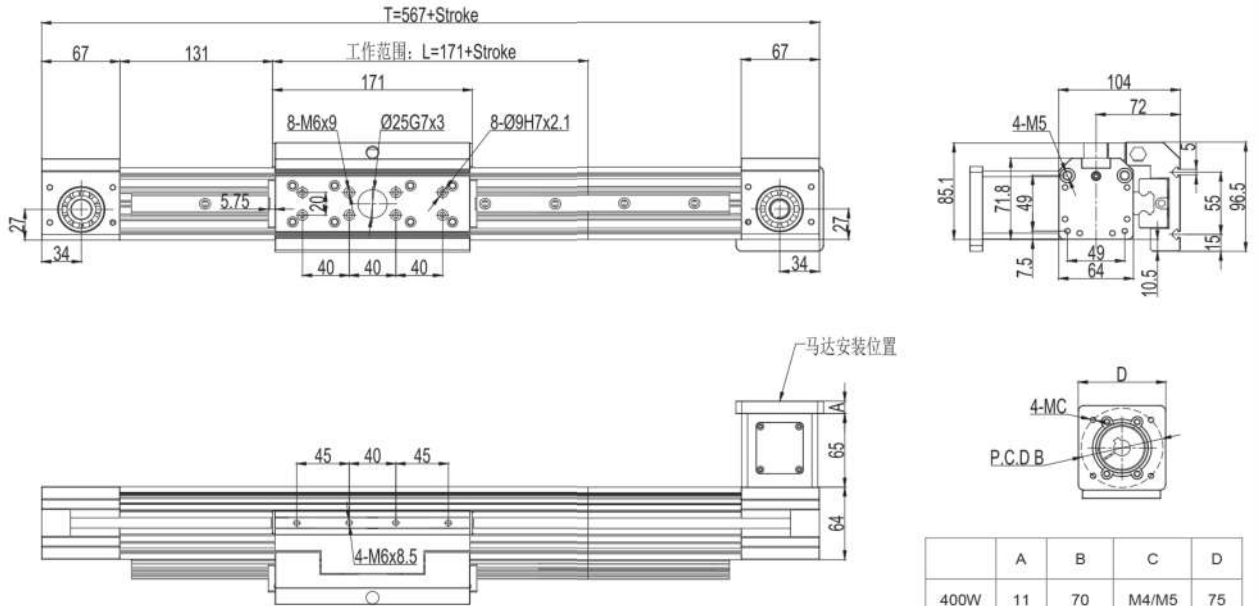

	A	B	C	D
400W	11	70	M4/M5	75
750W	21	90	M5/M6	80

行程	50	200	400	600	800	1000	1200	1400	1600	1800	2000	2200	2400	2600	2800	3000	3200	3400
L	221	371	571	771	971	1171	1371	1571	1771	1971	2171	2371	2571	2771	2971	3171	3371	3571
T	617	767	967	1167	1367	1567	1767	1967	2167	2367	2567	2767	2967	3167	3367	3567	3767	3967

■ EGB40S-LV-RK-P

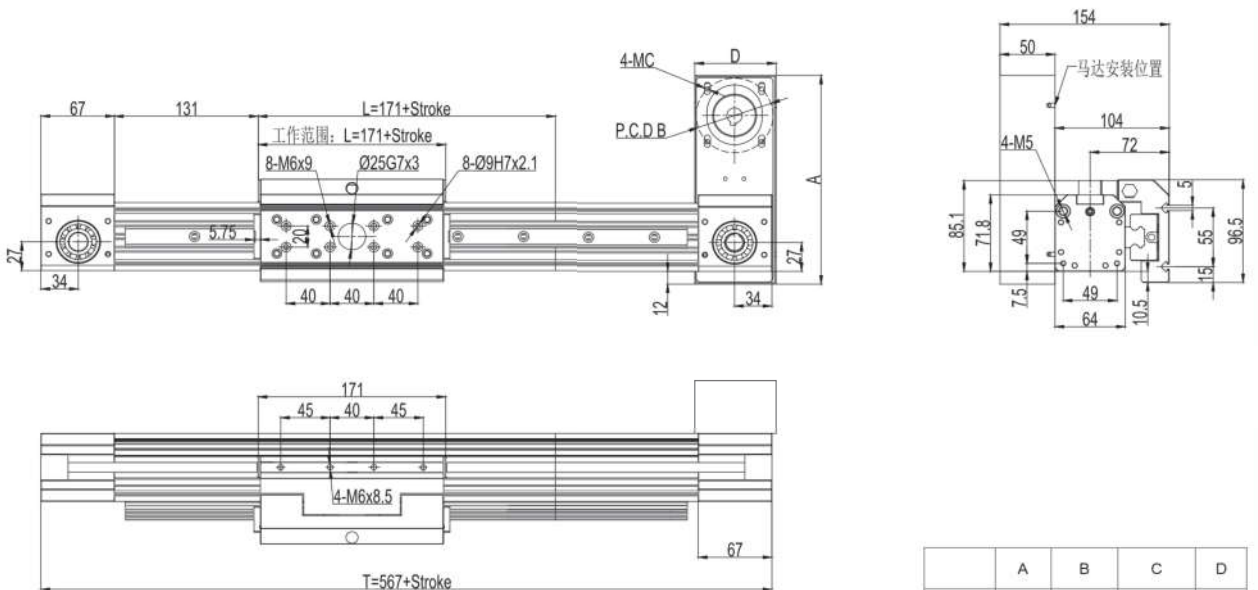

	A	B	C	D
400W	198	70	M4/M5	74
750W	209	90	M5/M6	84

行程	50	200	400	600	800	1000	1200	1400	1600	1800	2000	2200	2400	2600	2800	3000	3200	3400
L	221	371	571	771	971	1171	1371	1571	1771	1971	2171	2371	2571	2771	2971	3171	3371	3571
T	617	767	967	1167	1367	1567	1767	1967	2167	2367	2567	2767	2967	3167	3367	3567	3767	3967